

# **CADDX NetworX NX-4 Control/Communicator Installation Manual**

	Page
General Description .....	2
Ordering Information .....	2
Board Installation .....	2
Feature Definitions .....	3-7
Programming the LED Keypads .....	8
Programming the NX-4 .....	10-12
Types of Programming Data.....	10-12
Enrolling the Modules & Keypads.....	12
Communicator Formats .....	13
Reporting Events to Phone #1, #2, & #3.....	13-15
Zone Doubling .....	18
Programming the Outputs .....	19-20
Standard Zone Types (Configurations) .....	25
Programming Worksheets.....	26-32
SIA and Contact ID Formats .....	33-34
Expander Trouble Reporting Information .....	35
Wiring Diagram.....	36
Terminal Description.....	37
Telephone Interface Information .....	39
Underwriters Laboratories Information .....	40
Specifications & Warranty.....	Back Page

## NX-4 Control

### GENERAL DESCRIPTION

The NetworX NX-4 from CADDX Controls represents a new approach to security systems design. Drawing on our experience in the world market as the largest exporter of USA manufactured controls, CADDX has developed the most flexible, durable, and user-friendly control ever seen in our industry. Featuring sophisticated software which allows up to 8 users to interface with 8 zones, and a host of integrated fire, access, verification, and input/output modules, all reported with the most comprehensive and fast SIA and Contact ID formats. The NetworX design allows a fully loaded system to be housed in one single metal enclosure, establishing for the first time, a logical solution and design response to modular systems. A maximum of 8 keypads and 1 other module (excluding hardwire) can be added to expand the capabilities of the NX-4 unit.

### ORDERING INFORMATION

CADDX PART #	DESCRIPTION
NX-4 KIT	Includes NX-4 Control, NX-108 LED Keypad, & 16.5V 25VA Transformer
NX-4	NX-4 Control Only
NX-108	8 Zone LED Keypad
NX-116	16 Zone LED Keypad
NX-124	24 Zone LED Keypad
NX-148	Alphanumeric LCD Keypad
NX-200 **	Zone Doubling Kit (Includes 100 3.74k and 100 6.98k resistors)
NX-320 **	Smart Power Supply and Buss Extender
NX-408 #	8 Zone Wireless Expansion Module (UL LISTED PART #60-732)
NX-416 #	16 Zone Wireless Expansion Module (UL LISTED PART #60-732)
NX-448 #	48 Zone Wireless Expansion Module (UL LISTED PART #60-732)
NX-508	Eight Output Module
NX-534 **	Two-Way Listen In Module
NX-535 **	Two-Way Voice Module
NX-540 **	"Operator II" Telephone Interface Module
NX-580 **	Cellemetry Interface
NX-1308 **	8 Zone LED Door Design Keypad
NX-1316 **	16 Zone LED Door Design Keypad
NX-1324 **	24 Zone LED Door Design Keypad

\*\* These products have not been tested and approved by Underwriters Laboratories, Inc.

# These wireless devices are only UL listed for residential applications.

### IMPORTANT NOTES

1. The maximum number of zones available is 8 regardless of devices added. Information regarding Zone Doubling is located on page 7.
2. The NX-4 control panel will send an Expander Trouble once each hour if it senses that no devices have been enrolled. This report will show Expander Trouble - device zero (0).

### NX-4 BOARD INSTALLATION

The metal enclosure should be installed with the door opening from top to bottom. Refer to the diagram on the right.

Inside the can, there are four slots for board insertion, two on the top and two on the bottom of the can. These allow the PC board to be positioned vertically as shown in the diagram. When you slide the board between the grooves of the slots, make sure the terminal strip is toward the front for wire connections.

## FEATURE DEFINITIONS

**Abort**

If enabled, the NX-4 will wait the programmed number of seconds in location 40 prior to sending an alarm. During this delay time, the "Cancel" LED will flash. To abort the report, type in a code and press the [Cancel] key. The LED will extinguish. If the report is not aborted within the allotted time, the LED will extinguish when the report is sent. **(Loc. 40 and 110-149, pages 18 and 24)**

**AC Fail / Low Battery Report/Warning**

The NX-4 can be programmed to report AC failure and/or Low Battery conditions to the central station. It can also be programmed to sound the keypad immediately upon detection of the condition. The AC failure report/warning can be delayed. **(Loc. 37 and 39, page 17 - 18)**

**AC Power / Low Battery Sounder Alert**

If enabled, the NX-4 will beep the keypad sounder upon arming or disarming if the AC power is missing or a low battery has been detected. **(Loc. 23, page 16)**

**Arm / Disarm Codes**

The NX-4 can have 8 four-digit codes OR 8 six-digit codes to arm/disarm the control. All codes must have the same number of digits. The factory default for User #1 is [1]-[2]-[3]-[4] when using a 4-digit code, or [1]-[2]-[3]-[4]-[5]-[6] for a 6-digit code. This code can then be used to enter the new arm/disarm codes. **(Loc. 41, page 19)**

**Automatic Arming**

If programmed, the NX-4 will Auto Arm at the time specified in location 53. At that time, the keypad will beep for 50 seconds before the panel arms. The arming process will be stopped if a code is entered on the keypad. The NX-4 will attempt to arm after every 45 minutes of inactivity until the next Aopening® time (loc. 52), or until the system is armed. The 45-minute timer will be extended when there is activity in the building causing the "Ready" LED to turn off and on. If closing reports are sent, the user code will be 97. **(Loc. 23, and 52-55, pages 16 and 21. NOTE: For UL installations, this feature shall be disabled.)**

**Automatic Bypass / Instant Arming**

When enabled, the control panel can automatically bypass interior follower zones if an exit is not detected during the exit delay time. Entry delay zones can also be made instant. **(Loc. 23, segments 1 & 3, page 16)**

**Auto Cancel / Abort**

If enabled, Cancel and/or Abort features will be automatic (means pressing the Cancel button is not required.) The Cancel / Abort features, in Locations 23 and 40 respectively, must be enabled to permit this Auto feature to work. For proper operation of these features, ADialer Delay® must be enabled in ACharacteristic Select® of Locations 110-149 Zone Configuration Groups. **(Loc. 41, page 19)**

**Auto Test**

This feature will cause the panel to call the central station to report a communicator test at a specified interval. **(Loc. 37 - Seg. 4, and Loc. 51, pages 17 and 20)**

**Auxiliary Outputs**

The NX-4 has two programmable outputs that can be used to activate relays, LED-s, etc. **(See the terminal description on page 37 and locations 45-50, pages 19-20)**

**Auxiliary Power Over-current**

The NX-4 will illuminate the "Service" LED on the keypad whenever too much current is drawn from any device powered by the system. This condition can be reported to the central station. Power down the system to clear. **(Loc. 37, page 17)**

**Box Tamper**

The NX-4 has an input for a normally closed tamper switch (see terminal drawing). The Box Tamper can be programmed to report and/or sound the siren and/or the keypad. These terminals can be enabled or disabled in programming. **(Loc. 37 and 39, page 17)**

## NX-4 Control

### Built In Siren Driver

The NX-4 has a built-in 112db siren driver. When desired, this built-in driver can be easily converted to a 1 amp voltage output through programming. **(Loc. 37, page 17)**

### Bypass Toggle

This feature will enable the end user to toggle (turn on or off) the bypass of an interior zone with the system armed by pressing the [Bypass] key. **(Loc. 23, page 16)**

### Call Back

When enabled, the control will use the call back phone number to call the download computer before beginning a download. **(Loc. 21, page 16)**

### Cancel

If enabled, the NX-4 will send a "Cancel" report if when the system is disarmed and the [Cancel] button is pressed within 5 minutes of an alarm. Once the [Cancel] key is pressed, the "Cancel" LED will illuminate until the central station acknowledges the "Cancel" report. ADialer Delay® must be enabled in the ACharacteristic Select® of Loc. 110-149. **(Loc. 23, page 16)**

### Code Required Options

The NX-4 can be programmed to require a code for bypassing zones and/or initiating a download using the [\*]-[9]-[8] or [\*]-[9]-[9] function. **(Loc. 23 and 41, pages 16 and 19)**

### Communication Formats

The NX-4 can report in multiple formats. It is recommended that you use Contact ID or SIA formats if possible. If you wish to report to a pager or in a 4+2 format to a central station, you must program each code to be reported. **(Loc. 56-83 and 111-149, pages 22-25)**

### Configuration Groups

The NX-4 has 20 programmable configuration groups that determine how each zone will function and report. The default configuration groups (Zone Types) are listed on page 25. **(Loc. 111-149, pages 24-25)**

### Cross Zoning

This feature requires two or more trips on a zone or zones programmed as "cross zones" within a specified time before reporting an alarm. During the time between trips, the NX-4 can be programmed to sound the keypad and/or the siren. The NX-4 can also be programmed to report an alarm after two or more trips on the same zone. **(Loc. 37, 39, 40 and 110-149, pages 17 - 18, 24 - 25)**

### Dual / Split / Multiple Reports

The NX-4 can send communication reports to three different phone numbers for dual, split or multiple reports selectable by event. **(Loc. 4, 10, and 16, pages 13-15)**

### Duress Code

If a duress code is programmed, the NX-4 will send a duress signal whenever the panel is armed or disarmed with this code. If open/close reports are sent, the user code will be 254. **(Loc. 44, page 19)**

### Dynamic Battery Test

The NX-4 can be programmed to perform a Dynamic Battery Test for a selected duration the first time the panel is armed or disarmed every day, as well as by pressing [ ][4] Test Function. The NX-4 can also be programmed to perform a missing battery test every 12 seconds. **(Loc. 37 and 40, pages 17 and 18)**

### Entry-Guard

This unique low level arming mode has been developed to reduce the most common source of false alarms. When armed with the *Instant* light on, the opening of any zones designated as "Entry Guard zone" will initiate the keypad sounder and start the entry delay before creating an alarm. All other zones will function as normal. This arming mode will encourage system owners to use their system more frequently when the premise is occupied. **(Loc. 111-149, pages 24-25 NOTE: For UL installations, this feature shall be disabled.)**

### Exit Error

If enabled, the NX-4 will send an "Exit Error Report" if an entry/exit zone is faulted at the instant the exit delay expires. This report will be sent along with the user number that armed the system, if the panel is not disarmed before the entry delay expires. The alarm report will also be sent. Even if this feature is not enabled, the siren will sound if any entry/exit zone is faulted at the instant the exit delay expires. **(Loc. 23, page 16)**

### Expander Trouble

The NX-4 will report expander trouble to the central station if enabled. This condition will illuminate the "Service" LED on the keypad even if not reported. NOTE: The keypads are considered expanders. The number of the expansion devices reported can be found on page 35. **(Loc. 37, page 17)**

### Fail to Communicate

The NX-4 will illuminate the "Service" LED if a report fails to reach the central station. If enabled, when the next report is successfully communicated, a Fail to Communicate code will be reported. **(Loc. 37, page 17)**

### Fire Alarm Verification

When enabled, the NX-4 will verify a Fire alarm by requiring more than one trip on a smoke detector within a specified time before creating an alarm. NOTE: For household systems, the Fire Alarm Verification feature is NOT approved for use in California. This feature shall not be programmed into the control unit. **(Loc. 40, page 18)**

### Force Arming

When enabled, the NX-4 can be Force Armed with zones violated. Under this condition, if a force armable zone is not secure, the "Ready" LED will flash. At the end of the exit delay, these zones will become bypassed. If these zones become secured any time during the arming cycle, they will be unbypassed and active in the system. If "Bypass Report" is enabled, the force arming zones can be programmed to report bypass when they are Force Armed (default), or to not report bypass even if "Bypass Report" is enabled. **(Loc. 37, and 111-149, pages 17 & 24-25 NOTE: For UL installations, this feature shall be disabled.)**

### Group Bypass

A designated group of zones can be programmed to bypass by pressing [Bypass]-[0]-[Bypass]-[Bypass] prior to arming. **(Loc. 111-149, pages 24-25 NOTE: For UL installations, this feature shall be disabled.)**

### Immediate Restore By Zone

The NX-4 can be programmed to send alarm and restore reports as soon as they occur, or wait until the siren time has expired. **(Loc. 37, page 17)**

### Internal Event Log

Up to 185 events can be stored in memory along with the date and time of the event. These events can later be viewed through downloading or on the LCD keypad. **All reportable events report to the log.**

### Keypad Activated Panics

The NX-4 has three keypad activated panics that will send reports to the central station: Auxiliary 1 (Fire), Auxiliary 2 (Medical), and Keypad Panic. Auxiliary 1 will activate the steady (Fire) siren, Auxiliary 2 will sound the keypad, and the Keypad Panic can be programmed to be silent or audible (sound siren). **(Loc. 23, page 16)**

### Keypad Sounder Control

The NX-4 can be programmed to sound the keypad sounder for certain events. **(Loc. 39, page 18)**

### Keypad Tamper

If enabled, the NX-4 will disable the keypad for 60 seconds and communicate a tamper signal to the central station if 30 keypresses are entered without producing a valid code. **(Loc. 23, page 16)**

### LED Extinguish

This feature will extinguish all LED-s on the keypad, except the "Power" LED, after 60 seconds without a keypress. Pressing any numeric key will illuminate all LED-s. **(Loc. 23, page 16)**

## NX-4 Control

### Local Programming Lockout

This feature will disable programming of all locations or specified locations from the keypad. **(Loc. 21, page 16)**

### Log Full Report

A report can be sent to the central station when the event log is full. **(Loc. 37, page 17)**

### Lost Clock Service Light

The NX-4 can be programmed to illuminate the "Service" LED when the internal clock has an invalid time due to power loss. **(Loc. 37, page 17)**

### Manual Test

The NX-4 can be programmed to perform a bell and/or communicator test when [\*]-[4] is entered while the system is in the disarmed state. **(Loc. 37, page 17)**

### On Board Zone Disable

The four zones on the NX-4 panel can be disabled in order to have a completely wireless alarm system. **(Loc. 37, page 17)**

### Program Code

The factory default for the "Go To Program" code is [9]-[7]-[1]-[3] when using a 4-digit code or, if the 6-digit option is used, the default is [9]-[7]-[1]-[3]-[0]-[0]. The program code can also be used as an Arm/Disarm code. If used as an Arm/Disarm code, and open/close reports are sent, the user code will be 255. **(Loc. 43, page 19)**

### Quick Arm Feature

The NX-4 has a one button "Quick Arm" feature which can be used to arm the system by pressing the [Exit] key or the [Stay] key. If closing reports are sent, the user code will be 98. **(Loc. 23, page 16)**

### Recent Closing

If enabled, the NX-4 will send a "Recent Closing Report" to the central station if an alarm occurs within 5 minutes after the panel is armed. The user number that armed the system will also be sent. **(Loc. 23, page 16)**

### Re-exit

The NX-4 has the ability to restart the exit delay for a quick exit without disarming the system by pressing the [Exit] key while the system is armed. **(Loc. 23, page 16)**

### Shutdown

This mode will cause the keypads to turn off all LED-s, except the "Power" LED, and not accept keypresses. **(Loc. 21, page 16)**

### Siren Blast For Arming

The NX-4 can be programmed to give a one-second siren blast when the panel is armed, at the end of the exit delay, or when the central station receiver acknowledges the closing report. It can also give one blast for wireless arming and two blasts for wireless disarming. **(Loc. 37, page 17)**

### Siren Supervision

The NX-4 has a ASiren Supervision® circuit that will constantly monitor the siren on the NX-4 and can be programmed to report if the wires are cut. **(Loc. 37, page 17)**

### Silent Exit Option

The exit delay can be silenced by pressing [\*]-[Exit] before arming the control panel, or when using the re-exit feature. The exit delay can also be silenced permanently. **(Loc. 37, page 17)**

### Start/End Programming and End Downloading

A report can be sent when local programming is started and ended. A report can also be sent when a download session ends. **(Loc. 37, page 17)**

**Swinger Shutdown**

This feature allows a zone or zones to be automatically bypassed after a specified number of alarms. If immediate restore is enabled in location 37, the alarms (and restores, if enabled) will be sent as they occur. If immediate restore is not enabled, a second or subsequent alarm will not be sent until the siren times out. **(Loc. 37 and 38, page 17 NOTE: For UL installations, this feature shall be disabled.)**

**Temporal Siren Disable**

If disabled, the Fire Siren will be steady and Fire Voltage Out will be the same as Burglary (continuous). Otherwise, the Fire Siren will be temporal. **(Loc. 37, page 18 NOTE: For UL installations, do NOT disable.)**

**Two Call Answering Machine Defeat**

If enabled, to defeat an answering machine, two telephone calls must be made to the premises. On the first call, let the phone ring one or two times. The control panel will detect these rings and start a 45-second timer, during which, the control panel will answer the next call on the first ring. **This is not recommended for commercial applications. (Loc. 21, page 16)**

**Walk-Test Mode [\*] [Chime]**

If enabled, entering [\*] [Chime] followed by a user code will allow a walk-through zone test where all zones become silent and local (non-reporting). Each time a zone is faulted, the zone light on the LED keypad will illuminate and the chime will sound. The number of the faulted zone(s) will be displayed on the LCD keypad. It will also be entered into alarm memory and the internal log. To exit at any time during this mode, enter a user code. Otherwise, the Walk-Test Mode® will automatically exit after 15 minutes. **(Loc. 41, page 19)**

**Wireless Sensor Missing/Low Battery**

The NX-4 will send a report to the central station when a wireless sensor has detected a low battery or has not reported to the receiver. The "Service" LED will illuminate when either condition exists. **(Loc. 37, page 17)**

**Zone Bypassed Sounder Alert**

If this feature is enabled, the NX-4 will beep the keypad sounder upon arming if a zone is bypassed. **(Loc. 23, page 16)**

**Zone Doubling (Requires additional devices)**

Zone doubling can only be enabled when at least one other device is added to the basic system (consisting of the main control panel and one keypad). Additional devices can include wireless receivers, extra keypads, etc. If enabled, this feature allows you to use the four zones on the panel as eight normally closed zones. When this feature is used, European double E.O.L. configuration cannot be used. **THIS FEATURE DOES NOT INCREASE THE TOTAL NUMBER OF AVAILABLE ZONES BEYOND 8.** If one of the eight zones must be a fire zone, it must be one of Zones 1 - 4. The corresponding upper zone will become unavailable. For example, if Zone 4 is a fire zone, then Zone 8 will not be available. **(Loc. 37, page 17)**

**PROGRAMMING THE NX-4 LED KEYPADS**

This section describes how to program the address of each keypad as well as the options that are available. The address of the keypad is important because this is how the panel supervises the keypads. The factory default for the Master code is [1]-[2]-[3]-[4] when using a 4-digit code or [1]-[2]-[3]-[4]-[5]-[6] for a 6-digit code. The factory default for the "Go To Program" code is [9]-[7]-[1]-[3] for a 4-digit code or [9]-[7]-[1]-[3]-[0]-[0] for a 6-digit code.

**[\*]-[9]-[3] Set keypad options**

1. Enter [\*]-[9]-[3] [program code]. The "Service" LED will flash.
2. LEDs 1-8 can now be toggled on/off to enable/disable the following functions:
3. After enabling/disabling the desired functions, press [\*]

LED	KEYPAD FEATURE ENABLED
1	<b>RESERVED. DO NOT PROGRAM THIS AT ALL!</b>
2	<b>Enable Silent Keypad option</b> - silences the entry/exit sounder & chime only.
3	<b>Enable Ding Dong sound for Chime</b> - If off, chime will be a single tone. (See location 40, page 18)
4	<b>Enable Keypress Silence option</b> - silences the pulsing keypad sounder for 5 seconds when a key is pressed
5	<b>Enable Armed Status Suppression</b> - will not allow the keypad to display faulted or bypassed zones when the system is armed
6	<b>Enable Panic, Fire, Medical Beep tone</b> - will sound a short beep to verify that the keypress was accepted
7	<b>Suppresses the "Service" LED</b> - will not allow the "Service" LED to illuminate for any reason. If there is a system trouble, pressing [*]-[2] will still show the service menu. ( <b>NOTE:</b> For UL installations, the Service LED shall not be suppressed)
8	<b>RESERVED. This LED should always be OFF .</b>

**[\*]-[9]-[4] Set keypad number**

1. Enter [\*]-[9]-[4]-[program code]. The "Service" LED and the "Instant" LED will flash.
2. Enter the keypad number (1-8).
3. Press [\*]. The "Instant" LED will illuminate steady and the "Service" LED will remain flashing.
4. Enter [1]. The keypad will automatically exit this mode at this time.

**[\*]-[9]-[5] Set elapsed increments since last autotest**

1. Enter [\*]-[9]-[5]-[program code]. The "Service" LED will flash.
2. Enter [100's digit]
3. Enter [10's digit]
4. Enter [1's digit]
5. Press [#] to save and exit.

**[\*]-[9]-[6] Set system date**

1. Enter [\*]-[9]-[6]-[master code]. The "Service" LED will flash.
2. Enter [day of week (1=Sun)]
3. Enter [month 10's digit]
4. Enter [month 1's digit]
5. Enter [day 10's digit]
6. Enter [day 1's digit]
7. Enter [year 10's digit]
8. Enter [year 1's digit]

**[\*]-[9]-[7] Set system clock**

1. Enter [\*]-[9]-[7]-[master code]. The "Service" LED will flash.
2. Enter [hour 10's digit]
3. Enter [hour 1's digit]
4. Enter [minutes 10's digit]
5. Enter [minutes 1's digit]



**CHANGING USER CODES:**

1. Enter [\*]-[5]-[master code]. The "Ready" LED will flash.
2. Enter the 2 digit user number (always 2 digits such as "03" for user 3). The "Ready" LED will illuminate steady.
3. Enter the new user code designated for that individual. The "Ready" LED will flash indicating that the code was accepted. If it rejects the code, the sounder will beep 3 times. **Note for NX1300 Series LED Keypad:** The zone lights will illuminate specifying the first digit of the user code . (Lights 1-8 on = code is blank; lights 1-8 off = 0"; lights 1 and 8 = 9".) Use the up and down scroll keys to view the next digit or enter a new 4- or 6-digit user code . While using the scroll keys you can change any digit by entering a new digit. This will advance you to the next digit.
4. If another user code needs to be programmed, return to step 2.
5. Press [#] while the "Ready" LED is flashing to exit the User Code Programming Mode.

**ASSIGNING AUTHORITY LEVEL:**

1. Enter [\*]-[6]-[master code]. The "Ready" LED will flash.
2. Enter [2 digit user number] (always 2 digit such as 03 for user 3). The "Ready" LED will illuminate steady and the "Instant" LED will flash
3. Refer to this chart for the description of each LED. Turn the LED on for the features that you desire.

LED	ATTRIBUTES IF LED 8 IS OFF	LED	ATTRIBUTES IF LED 8 IS ON
<b>1</b>	<b>Reserved</b>	<b>1</b>	Activate output #1
<b>2</b>	Arm Only	<b>2</b>	Activate output # 2
<b>3</b>	Arm Only After Close Window	<b>3</b>	Reserved
<b>4</b>	Master arm/disarm (can program other codes)	<b>4</b>	Reserved
<b>5</b>	Arm/disarm code	<b>5</b>	Arm/disarm
<b>6</b>	Allowed to bypass zones (see location 23)	<b>6</b>	Bypass Zones
<b>7</b>	Code will send open / close reports	<b>7</b>	Open / Close Reporting
<b>8</b>	If this LED is on, LEDs 1-7 will use the chart to the right	<b>8</b>	If this LED is off, LEDs 1-7 use the chart to the left

4. Enter [\*] [\*]. This step returns you back to step 2 above. At this point you may enter another user number to assign attributes for. You may continue this procedure until you have assigned authority levels to all user numbers - or - you may press [#] key to exit the Assigning Authority Level Program.

**[\*]-[9]-[8]**

Pressing [\*]-[9]-[8] while the system is disarmed will cause the control to do a callback for a download.  
**NOTE: A VALID USER CODE MAY BE REQUIRED AFTER [\*]-[9]-[8] IF ENABLED IN LOCATION 41, PAGE 19.**

**[\*]-[9]-[9]**

Pressing [\*]-[9]-[9] while the system is disarmed will cause the control panel to seize the phone line for a download. **NOTE: A VALID USER CODE MAY BE REQUIRED AFTER [\*]-[9]-[9] IF ENABLED IN LOCATION 41, PAGE 19.**

**PROGRAMMING THE NX-4 CONTROL**

**ENTERING THE PROGRAM MODE:** To enter the Program Mode, press [\*]-[8]. At this time, the five function LEDs (Stay, Chime, Exit, Bypass, & Cancel) will begin to flash. Next, enter the "Go To Program Code" (FACTORY DEFAULT IS [9]-[7]-[1]-[3]). If the "Go To Program Code" is valid, the "Service" LED will flash and the five function LEDs will illuminate steady. You are now in the Program Mode and ready to select the module to program.

**SELECTING THE MODULE TO PROGRAM:** Since all modules connected to the NX-4 are programmed through the keypad, the module you are programming should be the first entry. To program the NX-4 Control Panel, enter [0]-[#]. The [0] is the module number of the control and the [#] is the entry key. Other module entry numbers can be found in their corresponding manuals.

**PROGRAMMING A LOCATION:** Once the number of the module to be programmed has been entered, the "Armed" LED will illuminate, indicating it is waiting for a programming location to be entered. Any location can be accessed by directly entering the desired programming location followed by the pound [#] key. If the location entered is a valid location, the "Armed" LED will extinguish, the "Ready" LED will illuminate and the binary data for the first segment of this location will be shown by the zone LED's. While entering new data, the "Ready" LED will begin flashing to indicate a data change in process. The flashing will continue until the new data is stored by pressing the [\*] key. Upon pressing the [\*] key, the keypad will advance to the next segment and display its data. This procedure is repeated until the last segment is reached. Pressing the [#] key will exit from this location, and the "Armed" LED will illuminate again waiting for a new programming location to be entered. If the desired location is the next sequential location, press the [POLICE] key. If the previous location is desired press the [FIRE] key. If the same location is desired press the [MEDIC] key. To review the data in a location, repeat the above procedure, pressing the [\*] key without any numeric data entry. Each time the [\*] key is pressed, the programming data of the next segment will be displayed for review.

**EXITING A LOCATION:** After the last segment of a location is programmed, pressing [\*] will save the data, exit that location, turn the "Ready" LED off and the "Armed" LED on. To exit before the last segment, press [#]. As before, you are now ready to enter another programming location. If an attempt is made to program an invalid entry for a particular segment, the keypad sounder will emit a triple error beep (beep, beep, beep), and remain in that segment awaiting a valid entry.

**EXITING THE PROGRAM MODE:** When all the desired changes in programming have been made, it is time to exit the program mode. Pressing the [Exit] key will exit this programming level, and go to the "Select a Module. To Program" level. If no additional modules are to be programmed, pressing the [Exit] key again will exit the program mode. If there is a module to be programmed, it may be selected by entering its address followed by the [#] key (see "Selecting the Module To Program" above). The procedure for programming these devices is the same as for the control panel, except the locations will be for the module selected.

**PROGRAMMING DATA**

Programming data is always one of two types. One type of data is numerical and can take on values from 0 -15 or 0 -255 depending on the location's segment. The other type of data is a feature selection type. Feature selection data is used to turn features on or off. Use the following procedures when working with these two data types:

**NUMERICAL DATA:** Numerical data is programmed by entering a number from 0-255 on the numeric keys of the system keypad. To view the data in a location, a binary process is used. With this process, the LED-s for zones 1 through 8 are utilized, and the numeric equivalents of their illuminated LED-s are added together to determine the data in a programming location. The numeric equivalents of these LED-s are as follows:

Zone 1 LED = <b>1</b>	Zone 2 LED = <b>2</b>	Zone 3 LED = <b>4</b>	Zone 4 LED = <b>8</b>
Zone 5 LED = <b>16</b>	Zone 6 LED = <b>32</b>	Zone 7 LED = <b>64</b>	Zone 8 LED = <b>128</b>

Example: If the numerical data to be programmed in a location is "66", press [6]-[6] on the keypad. The LED-s for Zone 2 and Zone 7 will become illuminated indicating 66 is in that location (2 + 64 = 66). See this example on page 10. Once the data is programmed, press the [\*] key to enter the data and advance to the next segment of that location. After the last segment of a location is programmed, pressing the [\*] key will exit that location, turn the "Ready" LED off and the "Armed" LED on. As before, you are now ready to enter another programming location. If an attempt is made to program a number too large for a particular segment, the keypad sounder will emit a triple beep, indicating an error, and remain in that segment awaiting a valid entry.

On the LCD keypad, the number in the location will be displayed. For locations with a maximum of 15, the hexadecimal equivalent will be displayed in parenthesis. Example: **11 (B)** or **14 (E)**.

**PROGRAMMING EXAMPLE - FIGURE 1 (Numerical Data)**

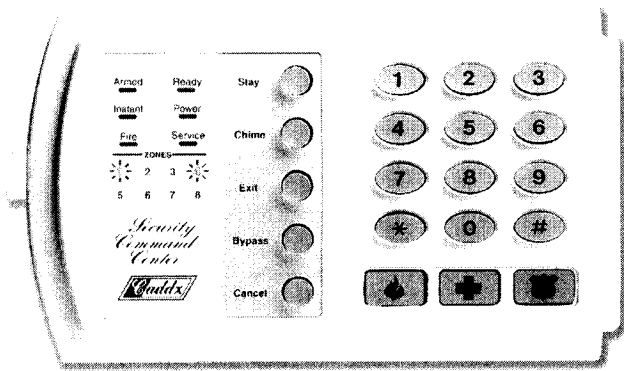

**Zone 1 LED = 1 } Data = 9**  
**Zone 4 LED = 8 }**

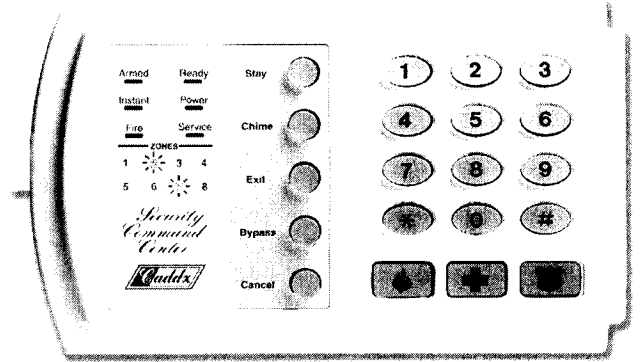

**Zone 2 LED = 2 } Data = 66**  
**Zone 7 LED = 64 }**

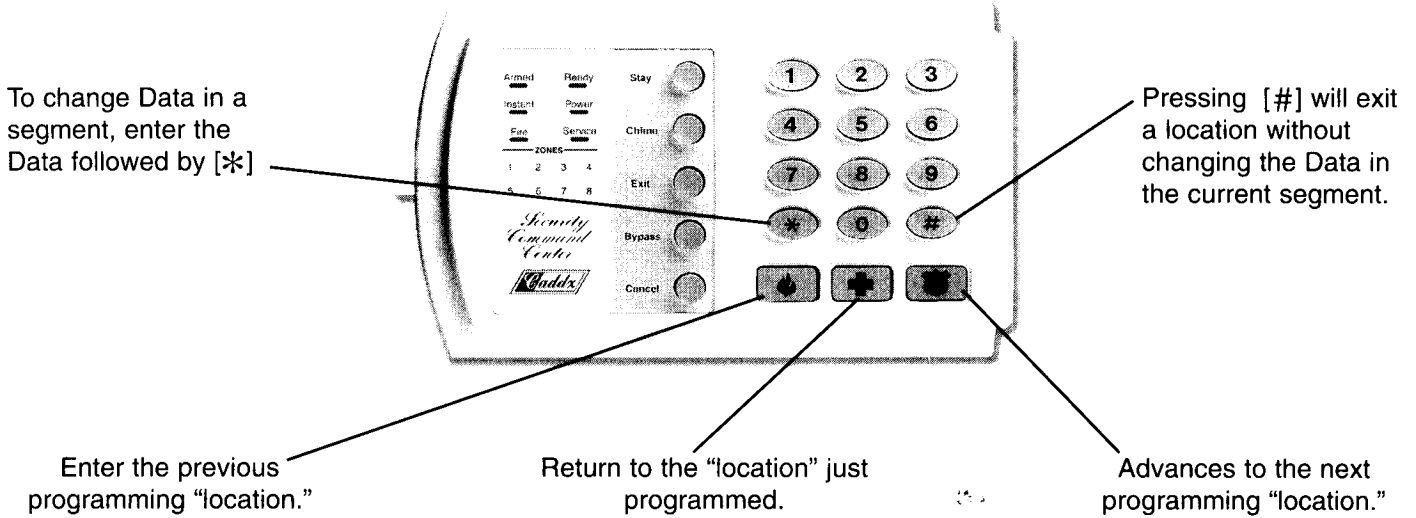

**PROGRAMMING EXAMPLE - FIGURE 2 (Feature selection Data)**

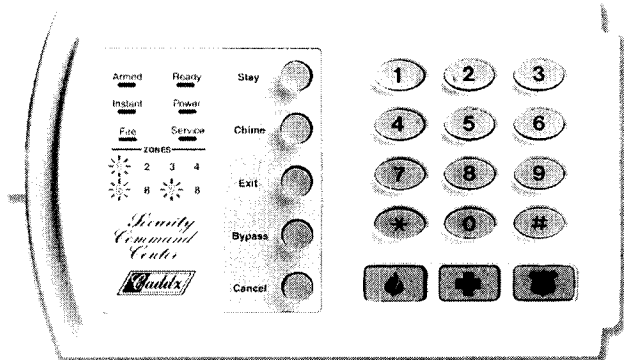

- Location 23 • Segment 1**
- 1 = Quick Arm
  - 2 = Re-Exit
  - 3 = Auto Bypass
  - 4 = Silent Keypad Panic
  - 5 = Audible Keypad Panic
  - 6 = Keypad Auxiliary 1
  - 7 = Keypad Auxiliary 2
  - 8 = Multi-Keypad Tamper

Press the key on the numeric Keypad that corresponds to the feature you wish to enable/disable. When an LED is "on" a feature is enabled, when "off" the feature is disabled. For example, with the 1, 5, & 7 LED's "on," Quick Arm, Audible Keypad Panic and Keypad Auxiliary 2 are enabled.

**FEATURE SELECTION DATA:** Feature selection data will display the current condition (on or off) of eight features associated with the programming location and segment selected. Pressing a button on the touchpad (1 thru 8) that corresponds to the "feature number" within a segment will toggle (on/off) that feature. Pressing any numeric key between [1] and [8] for selection of a feature, will make the corresponding LED illuminate (feature ON). Press the number again, and the LED will extinguish (feature OFF). You will see that numerous features can be selected from within one segment. For instance, if all eight features of a segment are desired, pressing [1]-[2]-[3]-[4]-[5]-[6]-[7]-[8] will turn on LED's 1 thru 8 as you press the keys, indicating that those features are enabled. **LCD Keypad Users Note: The numbers of the enabled features will be displayed. However, the features not enabled will display a hyphen (-).** After the desired setting of features is selected for this segment, press the [\*] key. This will enter the data and automatically advance to the next segment of the location. When you are in the last segment of a location and press the [\*] to enter the data, you will exit that location. This will now turn the "Ready" LED off and the "Armed" LED on. As before, you are now ready to enter another programming location.

### **LOADING FACTORY DEFAULTS**

To load the factory defaults, enter the program mode using the procedure on page 10, then type [9]-[1]-[0]-[#]. The keypad will beep 3 times indicating that the loading is in progress. The loading takes about 6 seconds.

### **ENROLLING MODULES AND KEYPADS**

For supervision purposes, the NX-4 has the ability to automatically find and store in its memory, the presence of all keypads, zone expanders, wireless receivers, and any other module connected to the data terminal. This allows these modules to be supervised by the control panel. To enroll the modules, enter the Program Mode of the NX-4 control panel as described on page 10. When the Program Mode is exited, the NX-4 control will automatically enroll the devices. The enrolling process takes about 12 seconds, during which time the "Service" LED will illuminate. User codes will not be accepted during the enrolling process. Once a module is enrolled, if it is not detected by the control, the "Service" LED will illuminate.

### **CONTROL PANEL PROGRAMMING LOCATIONS**

*(Note: Various locations have been intentionally omitted. Any attempts to access these locations will be followed by an error beep.)*

#### **LOCATION 0 - PHONE NUMBER 1 (20 segments, numerical data)**

The first telephone number is programmed in location 0. A "14" indicates the end of the phone number. Delays of four seconds can be programmed at any point in the phone number by programming a "13" in the appropriate segment. If tone dialing is desired, program a "15" in the segment where tone dialing should begin. If the entire number should be tone dialing, program a "15" in the first segment. Program an A11" for a A\*®, and a A12" for a A#@.

#### **LOCATION 1 - ACCOUNT CODE FOR THE PHONE #1 (6 segments, numerical data)**

The account code sent when Phone #1 is dialed is programmed in location 1. Program a A10" in the segment immediately after the last digit of the account code. If the account code is 6 digits long, program all 6 segments.

#### **LOCATION 2 - COMMUNICATOR FORMAT FOR PHONE #1 (1 segment, numerical data)**

Location 2 contains the communicator format used to transmit to the receiver connected to Phone #1. Consult the instructions for your central station receiver to determine which format is compatible. Select a format from the list on the following page. If you require a format other than those listed, review the override options described in location 18, to build the appropriate format. A "15" must be programmed in location 2 in addition to the entries in location 18 in order to create a special format. If this location contains a "0", the built-in communicator will be disabled, and the NX-4 will function as a local only control.

#### **LOCATION 3 - DIAL ATTEMPTS/BACKUP CONTROL FOR PHONE # 1 (2 segments, numerical data)**

**Segment 1- Dial attempts:** Location 3, Segment 1 is used to enter the number of dial attempts (1 to 15 Attempts) the communicator will make to Phone #1 before ending the notification process. Factory default is "8" and the communicator will make eight (8) attempts to the first number.

**Segment 2- Phone #1 Backup Control:** Programming a "0" in Segment 2 of this location will cause the NX-4 to make the designated number of attempts to Phone #2 before setting the "Fail To Communicate" condition and stop reporting. Programming a "1" in this segment will cause the NX-4 to stop trying to communicate after the designated number of attempts have been made to Phone #1. If a "2" is programmed in this segment, it will cause the NX-4 to make the dial attempts in increments of two. The first two attempts will be made to Phone #1, the next two attempts to Phone #2, then repeating until the total number of attempts designated in Segment 1 is completed.

**FORMAT SELECTIONS**

DATA	FORMAT	DESCRIPTION
<b>0</b>	Local	Communicator is disabled
<b>1</b>	Universal 4+2	Two digit event code 1800hz transmit 2300hz handshake double round parity 40pps
<b>2</b>	3+1 fast (or 4+1)	One digit event code 1900Hz transmit 1400Hz handshake double round parity 20pps
<b>3</b>	Reserved	Reserved
<b>4</b>	Pager	2 digit event code DTMF transmission
<b>5</b>	3/1 or 4/1 slow	1800hz transmit 2300hz handshake double round parity 20 p.p.s. hex capability
<b>6</b>	3/1 or 4/1 slow	1800hz transmit 1400hz handshake double round parity 20 p.p.s. hex capability
<b>7</b>	3/1 or 4/1 fast	1800hz transmit 2300hz handshake double round parity 40 p.p.s. hex capability
<b>8</b>	3/1 or 4/1 fast	1800hz transmit 1400hz handshake double round parity 40 p.p.s. hex capability
<b>9</b>	3/1 or 4/1 fast with parity	1800hz transmit 2300hz handshake single round w/parity 40 p.p.s. hex capability
<b>10</b>	3/1 or 4/1 fast with parity	1800hz transmit 1400hz handshake single round w/parity 40 p.p.s. hex capability
<b>11</b>	4+2 express	2 digit event code DTMF transmission
<b>12</b>	4+2 fast	Two-digit event code 1900hz transmit 1400hz handshake double round parity 20 p.p.s.
<b>13</b>	Ademco Contact ID	DTMF (see pages 33-34)
<b>14</b>	SIA	FSK (see pages 33-34)
<b>15</b>	Custom format	(See location 18, page 16)

**REPORTING EVENTS TO PHONE NUMBER 1**

Location 4 is used to select which events are reported to Phone #1. If dual or split reporting is not desired, location 4 should be used to select all events to Phone #1. If dual or split reporting is desired, location 4 should be used to select only those events that should be reported to Phone #1. If no events should be reported to Phone #1, location 4 should be programmed as "0" (disabled).

**LOCATION 4 - EVENTS REPORTED TO PHONE # 1 (2 segments, feature selection data)**

- Segment 1:**
- 1 = Alarms and Alarm Restores.
  - 2 = Opening and Closings.
  - 3 = Zone Bypass and Bypass Restores.
  - 4 = Zone Trouble and Trouble Restores.
  - 5 = Power Fail, Low Battery, Power Restore, and Low Battery Restore.
  - 6 = Bell Cut, Bell Cut Restore.
  - 7 = Test Reports.
  - 8 = Start and End programming, Download complete.
- Segment 2:**
- 1 = Zone and Box Tamper and Tamper Restore.
  - 2 = Auxiliary Power Over-current and Restore.
  - 3 = Wireless Sensor Missing and Restore.
  - 4 = Wireless Sensor Low Battery and Restore.
  - 5 = Expander Trouble and Restore.
  - 6 = Fail To Communicate.
  - 7 = Reserved.
  - 8 = Reserved.

**LOCATION 6 - PROGRAMMING PHONE #2 (20 segments, numerical data)**

Phone #2 is programmed in location 6. A "14" indicates the end of the phone number. Delays of four seconds can be programmed at any point in the phone number by programming a "13" in the appropriate segment. If tone dialing is desired, program a "15" in the segment where tone dialing should begin. If the entire number should be tone dialing, program a "15" in the first segment. Program an A11" for a A\*®, and a A12" for a A#®.

**LOCATION 7 - ACCOUNT CODE FOR THE PHONE #2 (6 segments of numerical data)**

The account code sent when Phone #2 is dialed is programmed in location 7. Program a A10" in the segment immediately after the last digit of the account code. If the account code is 6 digits long, program all 6 segments. If this location is left unprogrammed, account code 1 will be used when the second phone number is dialed.

**LOCATION 8 - COMMUNICATOR FORMAT FOR PHONE # 2 (1 segment, numerical data)**

Location 8 contains the communicator format used to transmit to the receiver connected to Phone #2. Consult the instruction manual for your central station receiver to determine which format is compatible, and select from the 15 formats listed on page 13. If you require a format other than those listed, review the override options described in Location 18 to build the appropriate format. A "15" must be programmed in location 8 in addition to the entries in location 18 in order to create a special format. If this location contains a "0", format 1 will be used when Phone #2 is dialed.

**LOCATION 9 - DIAL ATTEMPTS/BACKUP CONTROL FOR PHONE #2 (2 segments, numerical data)**

**Segment 1, Dial attempts:** Segment 1 of Location 9 is used to enter the number of dial attempts (1 to 15 attempts) the communicator will make to Phone #2 before ending the notification process. Factory default is "8" and the communicator will make the same number of attempts as those programmed in location 3.

**Segment 2, Phone #2 Backup Control:** Programming a "0" in Segment 2 of this location will cause the NX-4 to make the designated number of attempts to Phone #1 before setting the "Fail To Communicate" condition and stop reporting. Programming a "1" in this segment will cause the NX-4 to stop trying to communicate after the designated number of attempts have been made to Phone #2. If a "2" is programmed in this segment, it will cause the NX-4 to make the dial attempts in increments of two. The first two attempts will be made to Phone #2, the next two attempts to Phone #1, then repeating until the total number of attempts designated in Segment 1 is completed.

**REPORTING EVENTS TO PHONE NUMBER 2**

Phone #2 can be used to back up Phone #1 or for a second receiver to multi-report or split report events. Location 10 is used to select which events are reported to Phone #2. If dual or split reporting is not desired, location 10 should be left at the factory default of "0". If multi-reporting or split reporting is desired, location 10 should be used to select only those events that should be reported to Phone #2. If no events should be reported to Phone #2, location 10 should be "0".

**LOCATION 10 - EVENTS REPORTED TO PHONE #2 (2 segments of feature selection data)**

**Segment 1:**

- 1 = Alarms and Alarm Restores.
- 2 = Opening and Closings.
- 3 = Zone Bypass and Bypass Restores.
- 4 = Zone Trouble and Trouble Restores.
- 5 = Power Fail, Low Battery, Power Restore, and Low Battery Restore.
- 6 = Bell Cut, Bell Cut Restore.
- 7 = Test Reports.
- 8 = Start and End programming, Download complete.

**Segment 2:**

- 1 = Zone and Box Tamper and Tamper Restore.
- 2 = Auxiliary Power Over-current and Restore.
- 3 = Sensor Missing and Restore.
- 4 = Sensor Low Battery and Restore.
- 5 = Expander Trouble and Restore.
- 6 = Fail To Communicate.
- 7 = Reserved.
- 8 = Reserved.

**LOCATION 12 - PROGRAMMING PHONE #3 (20 segments, numerical data)**

Phone #3 is programmed in location 12. A "14" indicates the end of the phone number. Delays of four seconds can be programmed at any point in the phone number by programming a "13" in the appropriate segment. If tone dialing is desired, program a "15" in the segment where tone dialing should begin. If the entire number should be tone dialing, program a "15" in the first segment. Program an A11" for a A\*®, and a A12" for a A#®.

**LOCATION 13 - ACCOUNT CODE FOR PHONE #3 (6 segments, numerical data)**

The account code sent when Phone #3 is dialed is programmed in location 13. Program a A10" in the segment immediately after the last digit of the account code. If the account code is 6 digits long, program all 6 segments. If location 6 is left unprogrammed, account code 1 will be used when the Phone #3 is dialed.

**LOCATION 14 - COMMUNICATOR FORMAT FOR PHONE #3 (1 segment, numerical data)**

Location 14 contains the communicator format used to transmit to the receiver connected to phone #3. Consult the instruction manual for your central station receiver to determine which format is compatible, and select from the 15 formats listed on page 13. If you require a format other than those listed, review the override options described in Location 18 to build the appropriate format. A "15" must be programmed in location 14 in addition to the entries in location 18 in order to create a special format. If this location contains a "0", format 1 will be used when Phone #3 is dialed.

**LOCATION 15 - DIAL ATTEMPTS/BACKUP CONTROL FOR PHONE #3 (2 segments, numerical data)**

**Segment 1, Dial Attempts:** Segment 1 of Location 15 is used to enter the number of dial attempts (1 to 15 attempts) the communicator will try to Phone #3 before ending the notification process. Factory default is "8" and the communicator will make the same number of attempts as those programmed in location 3.

**Segment 2, Phone # 3 Backup Control:** Programming a "0" in Segment 2 of this location will cause the NX-4 to make the designated number of attempts to Phone #2 before setting the "Fail To Communicate" condition and stop reporting. Programming a "1" in this segment will cause the NX-4 to stop trying to communicate after the designated number of attempts have been made to Phone #3. If a "2" is programmed in this segment, it will cause the NX-4 to make the dial attempts in increments of two. The first two attempts will be made to Phone #3, the next two attempts to Phone #2, then repeating until the total number of attempts designated in Segment 1 is completed.

**REPORTING EVENTS TO PHONE NUMBER 3**

Phone #3 can be used for a third receiver to multi-report or split report events. Location 16 is used to select which events are reported to Phone #3. If dual or split reporting is not desired, location 16 should be left at the factory default of "0". If multi-reporting or split reporting is desired, and the split is based on the event type (such as alarm, open/close, etc.), then location 16 should be used to select only those events that should be reported to Phone #3. If no events should be reported to Phone #3, location 16 should be "0".

**LOCATION 16 - EVENTS REPORTED TO PHONE #3 (2 segments, feature selection data)**

- Segment 1:**
- 1 = Alarms and Alarm Restores.
  - 2 = Opening and Closings.
  - 3 = Zone Bypass and Bypass Restores.
  - 4 = Zone Trouble and Trouble Restores.
  - 5 = Power Fail, Low Battery, Power Restore, and Low Battery Restore.
  - 6 = Bell Cut, Bell Cut Restore.
  - 7 = Test Reports.
  - 8 = Start and End programming, Download complete.

- Segment 2:**
- 1 = Zone and Box Tamper and Tamper Restore.
  - 2 = Auxiliary Power Over-current and Restore.
  - 3 = Sensor Missing and Restore.
  - 4 = Sensor Low Battery and Restore.
  - 5 = Expander Trouble and Restore.
  - 6 = Fail To Communicate.
  - 7 = Reserved.
  - 8 = Reserved.

**LOCATION 18 - CUSTOM COMMUNICATOR FORMAT (See locations 2, 8, & 14)**

**Segment 1:** 1 = On for 1800hz transmit; Off for 1900hz.  
2= On for 2300hz handshake; Off for 1400hz.  
3= On for cksum parity; Off for double round parity.  
4= On for 2 digit event code; Off for 1 digit event code.  
5 & 6= Reserved.  
7= On for 20 p.p.s.; Off for 10 or 40 p.p.s.  
8= On for 10 p.p.s.; Off for 20 or 40 p.p.s.

**Segment 2 :** 1= On for pager format (no handshake required).  
2= On for 1400/2300 handshake.  
3 & 4 = Reserved  
5= On for Contact ID.  
6= On for SIA.  
7= On for Contact ID or 4+3.  
8= On for DTMF.

**Segment 3 & 4:** Reserved.

**LOCATION 19 - DOWNLOAD ACCESS CODE (8 segments, numerical data)**

Location 19 contains the eight-digit access code the NX-4 must receive from the downloading software before the panel will permit downloading to occur. The factory default code is 84800000.

**LOCATION 20 - NUMBER OF RINGS TO ANSWER (1 segment, numerical data)**

Location 20 contains the number of rings to answer for a download. Enter a number from A0" (disabled) to "15". Factory default is "8" and the NX-4 will answer on 8 rings.

**LOCATION 21 - DOWNLOAD CONTROL (1 segment, feature selection data)**

Location 21 contains the feature selections for the controlling of download sessions. The following features can be enabled or disabled using this location. (See Feature Definitions starting on page 3)

**Segment 1:**

- 1 - On enables two call answering machine defeat.
- 2 - Reserved.
- 3 - On requires call back before download session.
- 4 - Shutdown.
- 5 - ➤ On locks all local programming.
- 6 - ➤ On locks programming of all locations associated with the communicator
- 7 - ➤ On locks out download section. (If "On", locations 19 - 22 cannot be viewed from the keypad; can only be viewed from the keypad when "Off".)
- 8 - On enables call back at auto test interval.

➤ **These selections can only be viewed from the keypad and must be changed through downloading.**

**LOCATION 22 - DOWNLOAD CALL BACK NUMBER (20 segments, numerical data)**

If a telephone number is programmed into this location, and "Require Callback" is enabled in location 21, the control panel will hang up for approximately 36 seconds (ensuring that the calling party has disconnected), and then call back. If tone dialing is desired, program an "15" in the segment where tone dialing should begin. If the entire number should be tone dialing, program an A15" in the first segment. Four-second delays can be obtained anywhere in the sequence by programming a "13" in the appropriate delay location. **WARNING: THE CALLBACK PHONE NUMBER SHOULD ALWAYS BE REVIEWED FOR ACCURACY BEFORE DISCONNECTING.**

**LOCATION 23 - FEATURE AND REPORT SELECTIONS (3 segments, feature selection data)**

Location 23 is used to enable certain features that can be accessed or are visible to the user from the keypad of the system. In addition, certain communicator reports are enabled in location 23. This location contains 3 segments of 8 features each. (See Feature Definitions starting on page 3.)

**Segment 1:** 1 - On enables the Quick Arm feature.  
2 - On enables the Re-exit feature.  
3 - On enables the Automatic Bypass feature.  
4 - On enables the Silent Keypad Panic feature (**overrides the Audible Panic**).  
5 - On enables the Audible Keypad Panic feature.  
6 - On enables the Keypad Aux 1 feature (FIRE).  
7 - On enables the Keypad Aux 2 feature (MEDICAL).  
8 - On enables the Keypad Multiple Code Attempt Tamper feature.



- Segment 2:**
- 1 - On enables the LED Extinguish feature.
  - 2 - On enables the Require Code for Bypassing feature.
  - 3 - On enables the Zone Bypassed Sounder Alert feature.
  - 4 - On enables the AC Power/Low Battery Sounder Alert feature.
  - 5 - On enables Bypass toggle.
  - 6 - On enables Silent Auto Arm.
  - 7 - On enables the Automatic Instant feature.
  - 8 - Reserved.

- Segment 3:**
- 1 - On enables Opening and Closing reports.
  - 2 - On enables Zone Bypass reporting.
  - 3 - On enables Zone Restore reporting.
  - 4 - On enables Zone Trouble reporting.
  - 5 - On enables Zone Tamper reporting.
  - 6 - On enables the Cancel reporting.
  - 7 - On enables the Recent Closing report.
  - 8 - On enables the Exit Error report.

**LOCATION 24 - ENTRY / EXIT TIMERS (4 segments, numerical data)**

Location 24 is used to program the Entry/Exit times. There are 2 separate Entry/Exit times.

- Segment 1, Entry time 1:** This is the entry time that will be used when a delay 1 zone type initiates an entry delay. Valid entries are 10-255 seconds.
- Segment 2, Exit time 1:** This is the exit time that will be used for all zones designated as delay 1. Valid entries are 10-255 seconds.
- Segment 3, Entry time 2:** This is the entry time that will be used when a delay 2 zone type initiates an entry delay. Valid entries are 10-255 seconds.
- Segment 4, Exit time 2:** This is the exit time that will be used for all zones designated as delay 2. Valid entries are 10-255 seconds.

**LOCATION 25 - ZONES 1-8 ZONE TYPES (8 segments, numerical data)**

Location 25 contains the Zone Type (Configuration Group) for zones 1-8. Segment 1 is for zone 1, and Segment 8 is for zone 8. Default zone types are found in Table 2.1 on page 25. Refer also to the programming worksheets. To customize a Zone Configuration Group, refer to Locations 110 - 149 starting on page 24.

**LOCATION 37 - SIREN AND SYSTEM SUPERVISION (5 segments, feature selection data)**

Location 37 is used to enable various system feature and reporting options. (Refer to the feature definitions.)

- Segment 1:**
- 1 & 2 - Reserved.
  - 3 - On if siren blast at arming.
  - 4 - On if siren blast at exit expiration.
  - 5 - On if siren blast at closing kissoff.
  - 6 - On if siren sounds during a "Cross Zone" verification time.
  - 7 - On if siren sounds for a Zone or Box Tamper.
  - 8 - On if siren blasts 1 time for wireless arming; 2 times for wireless disarming.
- Segment 2:**
- 1 - On if siren driver should be a voltage output. Off if on board siren driver enabled.
  - 2 - On if siren sounds for expander trouble (required for UL installations).
  - 3 - On for zones to immediately restore. Off for zones to restore only when siren is off.
  - 4 - On if Dynamic Battery Test performed at arming. Off if performed at disarming. (See loc. 40)
  - 5 - On if Battery Missing Test is performed every 12 seconds.
  - 6 - On if Manual Bell Test performed during [\*]-[4] test function.
  - 7 - On if Manual Communicator Test performed during [\*]- [4] test function.
  - 8 - On if Box Tamper terminals on the control panel are enabled.
- Segment 3:**
- 1 - On if Box Tamper report enabled.
  - 2 - On if AC Fail reporting enabled.
  - 3 - On if Low Battery reporting enabled.
  - 4 - On if Aux. Power Over-current report enabled.
  - 5 - On if Siren Supervision report enabled.
  - 6 & 7 - Reserved.
  - 8 - On if Expander Trouble reporting enabled.

## NX-4 Control

**Segment 4:** 1 - On if Fail To Communicate report enabled.  
2 - On if Log Full report enabled.  
3 - On if Autotest report enabled.  
4 - On if Start/End programming report enabled.  
5 - On if End Download report enabled.  
6 - On if Sensor Low Battery report enabled.  
7 - On if Sensor Missing report enabled.  
8 - Reserved.

**Segment 5:** 1 = On enable Lost Clock service light.  
2 = On enables Zone Doubling (Must have extra devices added to basic system to enable, refer to page 7) (NX-200 Zone Doubling Kit required)  
3 = On disables On-Board 4 zones.  
4 = On will allow two trips on same cross-zone to activate an alarm.  
5 = On will **not** allow zones that are force armed to report bypass.  
6 = On enables Silent Exit option.  
7 = Use internal crystal for clock.  
8 = Disable Temporal Siren on Fire (**NOTE: For UL installations, do NOT disable.**) Refer to the feature definitions beginning on page 3.

### LOCATION 38 - SWINGER SHUTDOWN COUNT

Location 38 contains the number of trips on a zone before that zone is bypassed automatically. Refer to the feature definitions beginning on page 3. **NOTE: For UL installations, this feature shall be disabled.**

### LOCATION 39 - KEYPAD SOUNDER CONTROL (1 segment, feature selection data)

**Segment 1:** 1 & 2 - Reserved.  
3 - On if keypad sounds upon AC Power Failure.  
4 - On if keypad sounds when a Low Battery is detected.  
5 - On if keypad sounds during Cross Zone trip time.  
6 - On if keypad sounds for zone and box tampers.  
7 - Reserved.  
8 - On if keypad sounds for expander trouble (required for UL installations).

### LOCATION 40 - SYSTEM TIMERS (10 segments, numerical data)

Location 40 contains the duration of various system timing functions. Example: If you desire the duration of the Dynamic Battery Test to be 30 minutes, you should program [3]-[0]-[\*] in segment 1 of this location. The [3]-[0] is the number of minutes, and the [\*] stores the data and moves to the next segment of this location.

**Segment 1** Dynamic Battery Test duration in minutes 0-255 minutes ("**0**" = no test)

**Segment 2** AC Fail report delay in minutes 0-255 minutes.

**Segment 3** Power Up Delay in seconds 0-60 seconds ("0" = no power up delay).

**Segment 4** Siren Time in minutes 1-255 minutes.

**Segment 5** Reserved.

**Segment 6** Cross Zone time in minutes 0-255 ("**0**" = no cross zoning).

**Segment 7** Chime time in 50 mS (1/20th second) increments from 0-12 seconds ("0" = follows zone 255 latched).

**Segment 8** Dial delay in seconds 0-255 seconds (**0** no abort delay).

**Segment 9** Fire Alarm Verification time in seconds 120-255 seconds ("**0**" = no fire alarm verification).

**Segment 10** Listen-In time in seconds 0-255 ("0" = no Listen-In time).

### IMPORTANT NOTES

1. The "Listen-In" feature cannot be enabled for UL Listed systems. The "Dynamic Battery Test" feature cannot exceed four (4) hours. The dial delay shall be set to A0".
2. For household systems, the Fire Alarm Verification feature is NOT approved for use in California. This feature shall not be programmed into the control unit.

**LOCATION 41 - CODE REQUIREMENTS (1 segment, feature data)****Segment 1:**

- 1 = On enables the 6-digit code option. *If 6-digit option is enabled, all arm/disarm codes and the "Go To Program Code" must be 6 digits.* If this option is enabled, the default user 1 code is [1]-[2]-[3]-[4]-[5]-[6]. **NOTE: IF YOU ENABLE THIS OPTION, VERIFY THAT THE "GO TO PROGRAM CODE" IS A SIX-DIGIT CODE BEFORE EXITING PROGRAMMING.**
- 2 = On requires code entry for [\*]-[9]-[8] (perform call back download) and [\*]-[9]-[9] (answer incoming call for download) functions.
- 3 = Enable Auto Cancel/Abort. (Refer to definitions beginning on page 3.)
- 4 = Enable Walk-Test Mode. (Refer to definitions beginning on page 3.)
- 5-8 = Reserved.

**LOCATION 42 - GO TO PROGRAM CODE (6 segments, numerical data)**

Location 42 contains the "Go To Program Code". This location contains either a 4 or 6-digit code. *If the 6-digit code option is enabled in Location 41, this code must contain six (6) digits.* If this option is not enabled in location 41, the last 2 segments (digits) will be ignored. With the NX-4 disarmed, the "Go To Program Code" can be used to enter the Program Mode.

**LOCATION 43 - GO TO PROGRAM CODE AND AUTHORIZATION (1 segment, feature selection data)**

The "Go To Program Code" can be used as a standard arm/disarm code. When using the code to arm or disarm, the user ID is 255. (This code may not be changed in the Run Mode.)

**Segment 1:**

- 1 - Reserved.
- 2 - On enables "Go To Program Code" as an arm only code.
- 3 - On enables "Go To Program Code" as an arm only after closing.
- 4 - On enables "Go To Program Code" as a master arm/disarm code (can change user codes).
- 5 - On enables "Go To Program Code" as an arm/disarm code.
- 6 - On enables "Go To Program Code" to bypass zones.
- 7 - On enables "Go To Program Code" opening and closing reports.
- 8 - Reserved.

**LOCATION 44 - DURESS CODE (6 segments, numerical data)**

Location 44 contains the "Duress" code. This location contains either 4 or 6 digits. *If the 6-digit code option is enabled in Location 41, this code must contain six (6) digits.* If the 6-digit option is not enabled in location 41, the last 2 digits will be ignored.

**LOCATION 46 - AUXILIARY OUTPUT SPECIAL TIMING (2 segments, feature selection data)**

Location 46 contains special timing feature activation for the two auxiliary outputs. Segment 1 corresponds to output 1, Segment 2 corresponds to output 2.

**Segments 1-2:**

- 1 = On if output should be timed in minutes; Off if timed in seconds.
- 2 = On if output should latch; Off if output should be timed.
- 3 = On if output should stop timing upon code entry; Off if the output should continue to time upon code entry.
- 4 = On if output should only activate between the closing and opening time in loc. 52 and 53.
- 5 = On if output should only activate between the opening and closing time in loc. 52 and 53.
- 6 = On if output should be inverted (0 volts going to 12 volts when activated).
- 7 = Reserved.
- 8 = Reserved.

**LOCATION 47 - AUXILIARY OUTPUT #1, EVENT AND TIME (2 segments, numerical data)****Segment 1:**

Use the chart on page 20 to select the event that will activate Auxiliary Output 1.

**Segment 2:**

Program the timing from 0-255 (minutes or seconds, depending on data programmed in Segment 1, Location 46). Programming a "0" makes the output follow the event.

**LOCATION 48 - AUXILIARY OUTPUT #2, EVENT AND TIME (2 segments, numerical data)****Segment 1:**

Use the chart on page 20 to select the event that will activate Auxiliary Output 2.

**Segment 2:**

Program the timing from 0-255 (minutes or seconds, depending on data programmed in Segment 2, Location 46). Programming a "0" makes the output follow the event.

**AUXILIARY OUTPUT EVENT SELECTION**

DATA	EVENT	DATA	EVENT
0	Burglary Alarm	26	Fire Trouble
1	Fire Alarm	27	Chime
2	24 Hour Alarm	28	Expander Trouble
3	Trouble Alarm	29	Dynamic Battery Test Time
4	Tamper Alarm	30	Open Period
5	Yelping Siren (Burglary)	31	Closed Period
6	Temporal Siren (Fire)	32	Listen-In
7	Any Siren	33	Line Seizure
8	Any Bypass	34	Ground Start
9	AC Fail	35	Fail To Communicate
10	Low Battery	36	Reserved
11	Duress	37	Program Mode
12	Aux 1 Keypad Zone	38	Download In Process
13	Aux 2 Keypad Zone	39	Reserved
14	Panic Keypad Zone	40	Short Circuit (Over-current)
15	Keypad Tamper	41	Box Tamper
16	Autotest	42	Siren Tamper
17	Alarm Memory	43	Any Open
18	Entry	44	Any Short
19	Exit	45	Any Fault (Open/ Short on Non-Fire Zone)
20	Entry or Exit	46	Any Alarm
21	Armed State	47	Beeping Keypad
22	Disarmed State	48	Code Entry (See note below)
23	Ready	49	Key FOB Function 1
24	Not Ready	50	Key FOB Function 2
25	Fire		

**Notes:** When Event 48 is programmed, it is possible to program a user code's authorization to select which output(s) a particular code will activate. When LED 8 is on for an authorization, then LEDs 1- 2 correspond to that code activating outputs 1 & 2 respectively. **(See programming the LED keypads on page 8.)**

**Events 49 & 50 require NX-408, NX-416, or NX-448 wireless receivers to operate. If set to follow condition, these events will be 1 second.**

**LOCATION 51 - AUTOTEST CONTROL (4 segments, numerical data)**

- Segment 1:** Program a "1" if the interval is to be in hours; Program a "0" if in days. Add a A2" to suppress the daily test or a A3" to suppress the hourly test if any report has been sent.
- Segment 2:** Program the Autotest interval from 1-255 hours/days.
- Segment 3:** Program the Autotest report hour in 24-hour format (if the interval is in hours, this segment is ignored).
- Segment 4:** Program the Autotest report time, number of minutes after the hour.

**LOCATION 52 - OPENING TIME (2 segments, numerical data)**

Location 52 contains the time in 24 hour format the NX-4 enables codes designated as arm only after closing. This time is only valid on those days programmed in location 54. **NOTE: Opening time must be earlier than closing time for Auto Arm, Aux. Outputs, or Code Authorization to function properly.**

**Segment 1:** Program the hour of the opening time.

**Segment 2:** Program the minutes after the hour of the opening time.

**LOCATION 53 - CLOSING TIME/AUTOMATIC ARMING TIME (2 segments, numerical data)**

Location 53 contains the time in 24 hour format the NX-4 disables the disarm capability for codes designated as arm only after closing. This is also the time the Automatic Arming sequence will begin (if enabled in location 55). **NOTE: Opening time must be earlier than closing time for Auto Arm, Auxiliary Outputs, or Code Authorization to function properly.**

**Segment 1:** Program the hour of the closing / auto arm time.

**Segment 2:** Program the minutes after the hour of the closing / auto arm time.

**LOCATION 54 - DAYS OF THE WEEK SYSTEM IS OPEN (1 segment, feature selection data)**

Location 54 selects which days of the week system is open. On these days, arm only after close window codes will be able to arm and disarm during open window. **NOTE: If system is not programmed to be opened and is programmed to Auto-Arm (Location 55), the NX-4 will try to arm every 45 minutes for the duration of the closed period.** On days not selected here, arm only after close window codes will not disarm. (See locations 52 and 53 for the opening and closing times for the open days.)

- Segment 1:**
- 1 -Open on Sunday.
  - 2 -Open on Monday.
  - 3 -Open on Tuesday.
  - 4 -Open on Wednesday.
  - 5 -Open on Thursday.
  - 6 -Open on Friday.
  - 7 -Open on Saturday.
  - 8 -Reserved.

**LOCATION 55 - DAYS OF THE WEEK FOR AUTO ARMING (1 segment, feature selection data)**

Location 55 selects which days the system will auto arm. If a zone is faulted when the panel tries to auto arm, the zone will be bypassed.

- Segment 1:**
- 1 - Auto Arming on Sunday.
  - 2 - Auto Arming on Monday.
  - 3 - Auto Arming on Tuesday.
  - 4 - Auto Arming on Wednesday.
  - 5 - Auto Arming on Thursday.
  - 6 - Auto Arming on Friday.
  - 7 - Auto Arming on Saturday.
  - 8 - Reserved.

**COMMUNICATOR CODES FOR SLOW FORMATS ONLY**

**LOCATIONS 56- 83 ARE ONLY USED WHEN REPORTING EVENTS TO A PAGER OR USING A SLOW FORMAT SUCH AS 4+2. WHEN USING CONTACT ID OR SIA, THERE IS NO NEED TO PROGRAM THESE LOCATIONS.**

**LOCATION 56 - ARESTORE® CODE (1 segment, numerical data)**

Location 56 contains the event code for any zone "Restore" for a 4+2 format. The digit programmed in this location will be sent as the tens digit in place of the alarm event code. **The zone ID will always be reported as the ones digit of the zone number (i.e. 9 for zone 29).**

**LOCATION 57 - ABYPASS® CODE (1 segment, numerical data)**

Location 57 contains the event code for a zone "Bypass" for a 4+2 format. The digit programmed in this location will be sent as the tens digit. **The zone ID will always be reported as the ones digit of the zone number (i.e. 9 for zone 29).**

**LOCATION 58 - ATAMPER® CODE (1 segment, numerical data)**

Location 58 contains the event code for a zone "Tamper" for a 4+2 format. The digit programmed in this location will be sent as the tens digit. **The zone ID will always be reported as the zone number (i.e. 9 for zone 29).**

**LOCATION 59 - ATROUBLE® CODE (1 segment, numerical data)**

Location 59 contains the event code for a zone "Trouble" for a 4+2 format. The digit programmed in this location will be sent as the tens digit. **The zone ID will always be reported as the zone number (i.e. 9 for zone 29).**

**LOCATION 60 - ASENSOR LOW BATTERY® CODE (1 segment, numerical data)**

Location 60 contains the event code for a zone "Sensor Low Battery" for a 4+2 format. The digit programmed in this location will be sent as the tens digit. **The zone ID will always be reported as the zone number (i.e. 9 for zone 29).**

**LOCATION 61 - ASENSOR MISSING® CODE (1 segment, numerical data)**

Location 61 contains the event code for a zone "Sensor Missing" for a 4+2 format. The digit programmed in this location will be sent as the tens digit. **The zone ID will always be reported as the zone number (i.e. 9 for zone 29).**

**LOCATION 62 - ADURESS® CODE (2 segments, numerical data)**

Location 62 contains the tens and ones digits that will be sent for a 4+2 format if the Duress code is enabled in location 44. Segment 1 contains the tens digit, segment 2 contains the ones digit.

**LOCATION 63 - AKEYPAD AUXILIARY 1" CODE (2 segments, numerical data)**

Location 63 contains the tens and ones digits that will be sent for a 4+2 format if the keypad "Auxiliary 1" (FIRE) is enabled in location 23. Segment 1 contains the tens digit, segment 2 contains the ones digit.

**LOCATION 64 - AKEYPAD AUXILIARY 2" CODE (2 segments, numerical data)**

Location 64 contains the tens and ones digits that will be sent for a 4+2 format if the keypad "Auxiliary 2" (MEDICAL) is enabled in location 23. Segment 1 contains the tens digit, segment 2 contains the ones digit.

**LOCATION 65 - AKEYPAD PANIC® CODE (2 segments, numerical data)**

Location 65 contains the tens and ones digits that will be sent for a 4+2 format if the keypad "Panic" is enabled in location 23. Segment 1 contains the tens digit segment 2 contains the ones digit.

**LOCATION 66 - AKEYPAD MULTIPLE CODE ENTRY TAMPER® CODE (2 segments, numerical data)**

Location 66 contains the tens and ones digits that will be sent for a 4+2 format if the keypad "Multiple Code Entry" (Tamper) is enabled in location 23. Segment 1 contains the tens digit, segment 2 contains the ones digit.

**LOCATION 67 - ABOX TAMPER / BOX TAMPER RESTORE® CODES (4 segments, numerical data)**

Location 67 contains the tens and ones digits that will be sent for a 4+2 format if the "Box Tamper" feature is enabled in location 37. Segment 1 contains the tens digit of the "Box Tamper". Segment 2 contains the ones digit of the "Box Tamper". Segment 3 contains the tens digit of the "Box Tamper Restore". Segment 4 contains the ones digit of the "Box Tamper Restore".

**LOCATION 68 - AAC FAIL / AC FAIL RESTORE® CODES (4 segments, numerical data)**

Location 68 contains the tens and ones digits for a 4+2 format that will be sent if "AC Fail Reporting" is enabled. Segment 1 contains the tens digit of the "AC Fail Reporting". Segment 2 contains the ones digit of the "AC Fail Reporting". Segment 3 contains the tens digit of the "AC Fail Restore". Segment 4 contains the ones digit of the "AC Fail Restore".

**LOCATION 69 - ALOW BATTERY / LOW BATTERY RESTORE® CODES (4 segments, numerical data)**

Location 69 contains the tens and ones digits for a 4+2 format that will be sent if "Low Battery Reporting" is enabled. Segment 1 contains the tens digit of the "Low Battery Reporting". Segment 2 contains the ones digit of the "Low Battery Reporting". Segment 3 contains the tens digit of the "Low Battery Restore". Segment 4 contains the ones digit of the "Low Battery Restore".

**LOCATION 70 - AAUX POWER OVER-CURRENT / AUX POWER OVER-CURRENT RESTORE® CODES (4 segments, numerical data)**

Location 70 contains the tens and ones digits for a 4+2 format that will be sent if "Aux Power Over-current Reporting" is enabled. Segment 1 contains the tens digit of the "Aux Power Over-current Reporting". Segment 2 contains the ones digit of the "Aux Power Over-current Reporting". Segment 3 contains the tens digit of the "Aux Power Over-current Restore". Segment 4 contains the ones digit of the "Aux Power Over-current Restore".

**LOCATION 71 - ABELL TAMPER / BELL TAMPER RESTORE® CODE (4 segments, numerical data)**

Location 71 contains the tens and ones digits for a 4+2 format that will be sent if siren supervision reporting is enabled. Segment 1 contains the tens digit of the "Bell Tamper Reporting". Segment 2 contains the ones digit of the "Bell Tamper Reporting". Segment 3 contains the tens digit of the "Bell Tamper Restore". Segment 4 contains the ones digit of the "Bell Tamper Restore".

**LOCATION 74 - AEXPANDER TROUBLE / EXPANDER TROUBLE RESTORE® CODE (4 segments, numerical data)**

Location 74 contains the tens and ones digits for a 4+2 format that will be sent if "Expander Trouble Reporting" is enabled. Segment 1 contains the tens digit of the "Expander Trouble Reporting". Segment 2 contains the ones digit of the "Expander Trouble Reporting". Segment 3 contains the tens digit of the "Expander Trouble Restore". Segment 4 contains the ones digit of the "Expander Trouble Restore".

**LOCATION 75 - AFAIL TO COMMUNICATE® CODE (2 segments, numerical data)**

Location 75 contains the tens and ones digits for a 4+2 format that will be sent if the "Fail To Communicate Reporting" is enabled. Segment 1 contains the tens digit, segment 2 contains the ones digit.

**LOCATION 76 - ALOG FULL® CODE (2 segments, numerical data)**

Location 76 contains the tens and ones digits for a 4+2 format if the "Log Full Reporting" is enabled. Segment 1 contains the tens digit, segment 2 contains the ones digit.

**LOCATION 77 - AOPENING® CODE (1 segment, numerical data)**

Location 77 contains the tens digit of a 4+2 format if the "Opening Reporting" is enabled. **The ones digit is the ones digit of the user number that did the opening. If the user is greater than 9, the numbers will begin repeating.**

**LOCATION 78 - ACLOSING® CODE (1 segment, numerical data)**

Location 78 contains the tens digit of a 4+2 format if the "Closing Reporting" is enabled. **The ones digit is the ones digit of the user number that did the closing. If the user is greater than 9, the numbers will begin repeating.**

**LOCATION 79 - AAUTOTEST® CODE (2 segments, numerical data)**

Location 79 contains the tens and ones digits for a 4+2 format that will be sent if the "Autotest" or "Manual Test" is enabled. Segment 1 contains the tens digit segment 2 contains the ones digit.

**LOCATION 80 - ARECENT CLOSING AND EXIT ERROR® CODE (2 segments, numerical data)**

Location 80 contains the tens digit for a 4+2 format that will be sent if "Recent Closing" and/or "Exit Error Reporting" is enabled. Segment 1 contains the tens digit for the "Recent Closing Reporting". Segment 2 contains the digit for the "Exit Error Reporting". **The ones digit is the ones digit of the user who closed. If the user number is greater than 9, the numbers will begin repeating (i.e. 9 for user 29).** If it is required to report Recent Closings and Exit Errors for more than 9 users, Contact ID or SIA format must be used.

## NX-4 Control

### LOCATION 81 - ASTART PROGRAM AND END PROGRAM® CODES (4 segments, numerical data)

Location 81 contains the tens and ones digits for a 4+2 format that will be sent if "Start / End Programming Reporting" is enabled. Segment 1 contains the tens digit of the "Start Program Reporting". Segment 2 contains the ones digit of the "Start Program Reporting". Segment 3 contains the tens digit of the "End Program Reporting". Segment 4 contains the ones digit of the "End Program Reporting".

### LOCATION 82 - AEND DOWNLOAD® CODE (4 segments, numerical data)

Location 82 contains the tens and ones digits for a 4+2 format that will be sent if "End Downloading Reporting" is enabled. Segment 1 and 2 are reserved. Segment 3 contains the tens digit of the "End Download Reporting". Segment 4 contains the ones digit of the "End Download Reporting". **Note:** A start download report will be sent to the internal event log.

### LOCATION 83 - ACANCEL® CODE (1 segment, numerical data)

Location 83 contains the tens digit for a 4+2 format that will be sent if "Cancel Reporting" is enabled. Segment 1 contains the tens digit for the "Cancel Communicator Reporting". **The ones digit is the ones digit of the user who canceled. If the user number is greater than 9, the numbers will begin repeating (i.e. 9 for user 29).** If it is required to report Cancels for more than 9 users, Contact ID or SIA format must be used.

## CUSTOMIZING ZONE TYPES (Configuration Groups)

**NOTE: Locations 110-149 are used to change the zone types (configurations) as listed in the table on page 25. These locations are considered advanced programming and should only be changed with a thorough understanding of the operation of each bit.**

Table 1.1	GROUP CHARACTERISTIC SELECTIONS
<b>Segment 1</b>	1 = Fire (turn on if this is a fire zone). 2 = 24 hour (turn on for non-fire 24 hour zones). 3 = Reserved 4 = Follower (turn on for burglary zones that are Instant during non-entry times). 5 = Delay 1 zone (follows timer 1 entry and exit times). 6 = Delay 2 zone (follows timer 2 entry and exit times). 7 = Interior (turn on if zone should Automatically Bypass or Bypass for Stay Arming). 8 = Local only (turn on if this zone should not be reported).
<b>Segment 2</b>	1 = On will beep the keypad for alarm. 2 = On will sound the yelping siren for alarm. 3 = On will sound the temporal siren for alarm. 4 = On will chime. 5 = On will bypass. 6 = On will include in the group shunt. 7 = On is force armable. 8 = On is entry guard.
<b>Segment 3</b>	1 = RESERVED 2 = On enables Double End Of Line Tamper zone. (Mainly used for tamper on wireless zones) 3 = On enables Trouble Reporting zone. (Day zone and Fire zones) 4 = On enables Cross Zoning. 5 = On enables Dialer Delay zone. (See location 40, page 18) 6 = On enables swinger shutdown. (See location 38, page 18) 7 = On enables Restore reporting. 8 = On enables Listen-In. (See location 40, page 18)

### LOCATION 110 - GROUP 1 ALARM EVENT CODE (1 segment, numerical data)

Location 110 contains the event code sent for a Contact ID or SIA report. The desired event code should be chosen from the list on page 34. The zone ID will be that zone that is in alarm. If 4+2 format is being used, the number programmed in this location will be sent as the tens digit. When using 4+2 the digit in location 110 should be from 1-15. The zone ID for 4+2 formats will be the ones digit of the zone that is in alarm.

### LOCATION 111 - GROUP 1 CHARACTERISTIC SELECT (3 segments, feature selection data)

Use Table 1.1 AGroup Characteristic Selection® above to program this location.



**LOCATIONS 112 THRU 149** contain the remaining 19 Customized Zone Group information. The **even** numbered locations reflect the AGroup Alarm Event Code® and the **odd** numbered locations designate the Group Characteristics. Locations 112 and 113 correspond to Group 2; Locations 148 and 149 correspond to Group 20. Use the description found in Location 110 for programming the Alarm Event Codes, and use Table 1.1 shown on page 24 to select the Group Characteristics. Refer also to the Programming Worksheets.

**Table 2.1 STANDARD ZONE TYPES (Default Configurations)**

Zones can be programmed to be one of twenty different zone types (configurations). Zone types # 17 - 20 can be used for wireless or hardwired zones using European double EOL configuration. The default zone types are listed below. If none of the following zone types meet your needs, these configurations can be customized by programming locations 110-149.

DATA	DESCRIPTION OF STANDARD ZONE TYPES
"1"	<b>DAY ZONE</b> - Instant when system is armed trouble zone when system is disarmed.
"2"	<b>24-HOUR AUDIBLE</b> - Creates an instant yelping siren alarm regardless of the armed state of the panel.
"3"	<b>ENTRY/EXIT DELAY 1</b> - A trip will start entry delay 1. The lack of a trip during exit delay will enable the Automatic Bypass or Instant mode if so programmed.
"4"	<b>FOLLOWER WITH AUTO- BYPASS DISABLED</b> - This zone will be instant when the system is armed and no entry or exit delays are being timed. It is delayed during entry and exit delay times. This zone will not automatically bypass even if enabled in Segment 1 of Location 23.
"5"	<b>INTERIOR FOLLOWER WITH AUTO- BYPASS ENABLED</b> - This zone will be instant when the system is armed and no entry or exit delay is being timed. It is delayed during entry and exit delay times. This zone will automatically bypass if enabled in Segment 1 of Location 23.
"6"	<b>INSTANT</b> - This zone creates an instant alarm whenever it is tripped and the Armed LED is on.
"7"	<b>24-HOUR SILENT</b> - Creates an instant silent alarm regardless of the armed state of the control panel. It will not display on the keypad.
"8"	<b>FIRE</b> - This zone will light the Fire LED and sound the temporal siren each time the zone is shorted. It will also rapidly flash the Fire LED indicating a trouble if the zone is open.
"9"	<b>ENTRY/EXIT DELAY 2</b> - A trip will start entry delay 2. The lack of a trip during exit delay will enable the Automatic Bypass or Instant mode if so programmed.
"10"	<b>24-HOUR SILENT SUPERVISED</b> - Creates an instant silent alarm regardless of the armed state of the control panel. It will display on the keypad.
"11"	<b>RESERVED</b>
"12"	<b>INTERIOR FOLLOWER WITH "CROSS ZONE" ENABLED</b> - This zone will be instant when the system is armed and no entry or exit delay is being timed. It is delayed during entry and exit delay times. If a "Cross Zone" is not being timed it will start a "Cross Zone" timer. If a "Cross Zone" is being timed it will create an instant alarm. This zone will automatically bypass when enabled in Segment 1 of Location 23.
"13"	<b>INSTANT ENTRY GUARD</b> - This zone creates an instant alarm whenever it is tripped and the Stay LED is off. It will start an entry delay time 2 if it is tripped and the system is armed and the Stay LED is on.
"14"	<b>ENTRY/EXIT DELAY 1 WITH GROUP BYPASS ENABLED</b> - A trip will start entry delay 1. This zone will bypass when the "Group Bypass" command is entered at the keypad. The lack of a trip during exit delay will enable the Automatic Bypass or Instant mode if so programmed.
"15"	<b>INTERIOR FOLLOWER WITH GROUP BYPASS ENABLED</b> - This zone will be instant when the system is armed and no entry or exit delays are being timed. It is delayed during entry/exit delay times. This zone will bypass when the "Group Bypass" command is entered at the keypad. This zone will automatically bypass if enabled in Segment 1 of Location 23.
"16"	<b>INSTANT WITH GROUP BYPASS ENABLED</b> - This zone creates an instant alarm whenever it is tripped and the Armed LED is on. This zone will bypass when the "Group Bypass" command is entered at the keypad.
"17"	<b>ENTRY/EXIT DELAY 1 WITH TAMPER ENABLED</b> -A trip will start entry delay 1. The lack of a trip during exit delay will enable the Automatic Bypass or Instant mode if so programmed. <b>This configuration group can be used to enable tamper on a wireless transmitter.</b>
"18"	<b>INTERIOR FOLLOWER WITH TAMPER AND AUTO-BYPASS ENABLED</b> - This zone will be instant when the system is armed and no entry or exit delay is being timed. It is delayed during entry and exit delay times. This zone will automatically bypass if enabled in Segment 1 of Location 23. <b>This configuration group can be used to enable tamper on a wireless transmitter.</b>
"19"	<b>INSTANT WITH TAMPER ENABLED</b> - This zone creates an instant alarm whenever it is tripped and the Armed LED is on. <b>This configuration group can be used to enable tamper on a wireless transmitter.</b>
"20"	<b>ENTRY/EXIT DELAY 2 WITH TAMPER ENABLED</b> -A trip will start entry delay 2. The lack of a trip during exit delay will enable the Automatic Bypass or Instant mode if so programmed. <b>This configuration group can be used to enable tamper on a wireless transmitter.</b>





**NX-4 Control**

LOC	PG	DESCRIPTION	DEFAULT	DATA	
37	17	SIREN AND SYSTEM SUPERVISION			
		Segment #1 (Circle numbers to program)			
		1	Reserved.		
		2	Reserved.		
		3	Siren blast at arming.		
		4	Siren blast at exit delay expiration.		
		5	Siren blast at closing kiss-off.		
		6	Siren sounds during a cross zone verification time.		
		<b>7</b>	<b>Siren sounds for a tamper.</b>		
		8	Siren blast one time for wireless arming, two times for wireless disarming.		
		Segment #2 (Circle numbers to program)			
		1	Convert siren driver to voltage out.		
		2	Siren sounds for expander trouble (required for U.L.).		
		3	Immediate Restore by Zone.		
		4	Dynamic battery test performed upon arming.		
		5	Battery missing test performed every 12 seconds.		
		<b>6</b>	<b>Manual bell test performed during [x]-[4] test function.</b>		
		7	Manual communicator test performed during [*]-[4] test function.		
		8	Box tamper enabled.		
		Segment #3 (Circle numbers to program)			
1	Box Tamper report enabled.				
2	AC Fail report enabled.				
3	Low Battery report enabled.				
4	Auxiliary power over current report enabled.				
5	Siren supervision report enabled.				
6	Reserved.				
7	Reserved.				
8	Expander trouble report enabled.				
Segment #4 (Circle numbers to program)					
1	Failure To Communicate report enabled.				
2	Log Full report enabled.				
3	Autotest report enabled.				
4	Start and End Programming report enabled.				
5	End Download report enabled.				
6	Sensor Low Battery report enabled.				
7	Sensor Missing report enabled.				
8	Reserved.				
Segment #5 (Circle numbers to program)					
1	Lost Clock service LED enable.				
2	Zone Doubling enable. (Requires additional devices, see page 7)				
3	Disable on-board four zones.				
4	Enables two trips on the same cross-zone to activate the alarm.				
5	Disables bypass reports for force armed zones				
6	Silent exit.				
7	Clock uses internal crystal.				
8	Disable Temporal Siren on Fire. ( <b>Do NOT disable for UL installations.</b> )				
38	18	SWINGER SHUTDOWN COUNT	<b>0</b>	-	

LOC	PG	DESCRIPTION	DEFAULT	DATA	
39	18	KEYPAD SOUNDER CONTROL			
		Segment #1 (Circle numbers to program)			
		1	Reserved.		
		2	Reserved.		
		3	Keypad sounds upon AC Power Failure.		
		4	Keypad sounds upon Low Battery Detection.		
		5	Keypad sounds during Cross Zone Trip Time.		
		<b>6</b>	<b>Keypad sounds for Tamper Alarm.</b>		
		7	Reserved.		
8	Keypad sounds for expander trouble (required for UL).				
40	18	SYSTEM TIMERS			
		Segment #1 Dynamic Battery Test duration (0-255 min.)	<b>0</b>	_	
		Segment #2 AC Failure report delay (0-255 minutes)	<b>5</b>	_	
		Segment #3 Power Up Delay (0-60 seconds)	<b>0</b>	_	
		Segment #4 Siren Time (1-255 minutes)	<b>8</b>	_	
		Segment #5 Reserved	<b>0</b>	_	
		Segment #6 Cross Zone Time (0-255 minutes)	<b>5</b>	_	
		Segment #7 Chime Time in 50 mS increments (0-255)	<b>3</b>	_	
		Segment #8 Dialer delay ( 0-255 seconds)	<b>0</b>	_	
		Segment #9 Fire Alarm Verification Time (120-255 sec.)	<b>0</b>	_	
Segment #10 Listen-In Time (0-255 seconds)	<b>0</b>	_			
41	19	USER CODE REQUIREMENTS			
		Segment #1 (Circle numbers to program)			
		1	Enables six digit code option. All arm/disarm/Go To Program codes require six digits		
		2	Requires valid user code entry for [*]-[9]-[8] and [*]-[9]-[9] functions to work.		
		3	Enables Auto Cancel/Abort.		
4	Enables Walk Test mode.				
5-8	Reserved.				
42	19	GO TO PROGRAM CODE	<b>9-7-1-3-0-0</b>		
43	19	GO TO PROGRAM CODE AND AUTHORIZATION			
		Segment #1 (Circle numbers to program)			
		1	Reserved.		
		2	Enables "Go To Program Code" as an arm only code.		
		3	Enables "Go To Program Code" as an arm only after closing.		
		4	Enables "Go To Program Code" as a master arm/disarm code (can change user codes)		
		5	Enables "Go To Program Code" as an arm/disarm code.		
		6	Enables "Go To Program Code" to bypass zones.		
		7	Enables "Go To Program Code" opening and closing reports.		
8	Reserved.				
44	19	DURESS CODE	<b>15-15-15-15-15-15</b>		
46	19	AUXILIARY OUTPUTS 1 & 2 SPECIAL TIMING			
		Segments	1	2	
		Auxiliary output timed in minutes.	1	1	
		Auxiliary output to latch.	2	2	
		<b>Auxiliary output to stop timing upon user code entry.</b>	<b>3</b>	<b>3</b>	
		Auxiliary output to activate only between closing and opening time.	4	4	
		Auxiliary output to activate only between opening and closing time.	5	5	
		Invert auxiliary output (0 volts going to 12 volts when activated).	6	6	
		Reserved	7	7	
Reserved	8	8			

**NX-4 Control**

LOC	PG	DESCRIPTION	DEFAULT	DATA														
47	19	AUXILIARY OUTPUT #1, EVENT & TIME																
		<b>Segment #1:</b> Program the event number for output #1.	<b>0= Burglary alarm</b>															
		<b>Segment #2:</b> Program the timing for output #1 here .	<b>10 seconds</b>															
48	19	AUXILIARY OUTPUT #2, EVENT & TIME																
		<b>Segment #1:</b> Program the event number for output #2.	<b>1= Fire alarm</b>															
		<b>Segment #2:</b> Program the timing for output #2 here .	<b>10 seconds</b>															
51	20	AUTOTEST CONTROL																
		<b>Segment #1:</b> Program a "1" if the interval is hours, a "0" if in days. Add a A2" to suppress the daily test or a A3" to suppress the hourly test.	<b>0</b>															
		<b>Segment #2:</b> Program the autotest interval from 1-255 days or hours.	<b>24</b>															
		<b>Segment #3:</b> Program the autotest report in 24 hour time format.	<b>2</b>															
52	21	<b>Segment #4:</b> Program the autotest report time, minutes after the hour.	<b>0</b>															
		OPENING TIME																
53	21	<b>Segment #1:</b> Program the hour of the opening time.	<b>8</b>															
		<b>Segment #2:</b> Program the minutes after the hour of the opening time.	<b>0</b>															
		CLOSING TIME / AUTO ARMING TIME																
54	21	<b>Segment #1:</b> Program the hour of the closing time/auto arming time.	<b>20</b>															
		<b>Segment #2:</b> Program the minutes after hour of closing / auto arming time.	<b>0</b>															
55	21	DAYS OF THE WEEK SYSTEM IS OPEN																
		<table border="1"> <tr> <td><b>1</b></td> <td><b>Sunday</b></td> <td><b>5</b></td> <td><b>Thursday</b></td> </tr> <tr> <td><b>2</b></td> <td><b>Monday</b></td> <td><b>6</b></td> <td><b>Friday</b></td> </tr> <tr> <td><b>3</b></td> <td><b>Tuesday</b></td> <td><b>7</b></td> <td><b>Saturday</b></td> </tr> <tr> <td><b>4</b></td> <td><b>Wednesday</b></td> <td><b>8</b></td> <td><b>Reserved</b></td> </tr> </table>	<b>1</b>	<b>Sunday</b>	<b>5</b>	<b>Thursday</b>	<b>2</b>	<b>Monday</b>	<b>6</b>	<b>Friday</b>	<b>3</b>	<b>Tuesday</b>	<b>7</b>	<b>Saturday</b>	<b>4</b>	<b>Wednesday</b>	<b>8</b>	<b>Reserved</b>
<b>1</b>	<b>Sunday</b>	<b>5</b>	<b>Thursday</b>															
<b>2</b>	<b>Monday</b>	<b>6</b>	<b>Friday</b>															
<b>3</b>	<b>Tuesday</b>	<b>7</b>	<b>Saturday</b>															
<b>4</b>	<b>Wednesday</b>	<b>8</b>	<b>Reserved</b>															
55	21	DAYS OF THE WEEK "AUTO ARMING" WILL OCCUR																
		<table border="1"> <tr> <td>1</td> <td>Sunday</td> <td>5</td> <td>Thursday</td> </tr> <tr> <td>2</td> <td>Monday</td> <td>6</td> <td>Friday</td> </tr> <tr> <td>3</td> <td>Tuesday</td> <td>7</td> <td>Saturday</td> </tr> <tr> <td>4</td> <td>Wednesday</td> <td>8</td> <td>Reserved</td> </tr> </table>	1	Sunday	5	Thursday	2	Monday	6	Friday	3	Tuesday	7	Saturday	4	Wednesday	8	Reserved
1	Sunday	5	Thursday															
2	Monday	6	Friday															
3	Tuesday	7	Saturday															
4	Wednesday	8	Reserved															

**LOC 56 - 83 COMMUNICATOR CODES FOR SLOW SPEED FORMATS ONLY**

LOC	PG	DESCRIPTION	DEFAULT	DATA
56	22	RESTORE COMMUNICATOR CODE	<b>14</b>	--
57	22	BYPASS COMMUNICATOR CODE	<b>0</b>	--
58	22	TAMPER COMMUNICATOR CODE	<b>0</b>	--
59	22	TROUBLE COMMUNICATOR CODE	<b>0</b>	--
60	22	SENSOR LOW BATTERY COMMUNICATOR CODE	<b>0</b>	--
61	22	SENSOR MISSING COMMUNICATOR CODE	<b>0</b>	--
62	22	DURESS	<b>0-0</b>	--
63	22	AUXILIARY 1	<b>0-0</b>	--

LOC	PG	DESCRIPTION	DEFAULT	DATA
64	22	AUXILIARY 2	<b>0-0</b>	--
65	22	KEYPAD PANIC	<b>0-2</b>	--
66	22	KEYPAD MULTIPLE CODE ENTRY TAMPER	<b>0-0</b>	--
67	22	BOX TAMPER / BOX TAMPER RESTORE	<b>0-0-0-0</b>	----
68	23	AC FAIL / AC RESTORE	<b>0-0-0-0</b>	----
69	23	LOW BATTERY / LOW BATTERY RESTORE	<b>0-0-0-0</b>	----
70	23	POWER SHORT / POWER SHORT RESTORE	<b>0-0-0-0</b>	----
71	23	BELL TAMPER / BELL TAMPER RESTORE	<b>0-0-0-0</b>	----
74	23	EXPANDER TROUBLE / EXPANDER TROUBLE RESTORE	<b>0-0-0-0</b>	----
75	23	FAILURE TO COMMUNICATE	<b>0-0</b>	--
76	23	LOG FULL COMMUNICATOR CODE	<b>0-0</b>	--
77	23	OPENING CODE COMMUNICATOR CODE	<b>11</b>	-
78	23	CLOSING COMMUNICATOR CODE	<b>12</b>	-
79	23	AUTOTEST COMMUNICATOR CODE	<b>0-0</b>	--
80	23	RECENT CLOSING AND EXIT ERROR	<b>0-0</b>	--
81	24	START PROGRAMMING / END PROGRAMMING	<b>0-0-0-0</b>	----
82	24	END DOWNLOAD	<b>0-0-0-0</b>	----
83	24	CANCEL COMMUNICATOR CODE	<b>0</b>	-

### CUSTOMIZING ZONE TYPES (GROUPS)

These locations are considered advanced programming and should only be changed with a thorough understanding of the operation of each bit. These locations are used to design or customize zones when the Standard Zones Types in Table 2.1 on page 25 do not fit your needs.

110	24	GROUP 1 ALARM EVENT CODE	<b>8</b>	-	
111	24	GROUP 1 CHARACTERISTIC SELECT			
		<b>Segment #1</b> (Circle numbers to program)			
		1	Fire (enable for fire zone)	5	Delay 1 zone (enable to follow Timer 1 Entry/Exit times)
		2	24 Hour (enable for non-fire 24 hour zone)	6	Delay 2 zone (enable to follow Timer 1 Entry/Exit times)
		3	Reserved	7	Interior (Enable for auto bypass or stay arming)
		4	Follower (enable for burg zones that are instant during non-entry times)	8	Local Only (enable if zone is not to be reported)
		<b>Segment #2</b> (Circle numbers to program)			
		1	<b>Keypad audible on alarm.</b>	5	<b>Bypassable.</b>
		2	<b>Yelping siren on alarm.</b>	6	Group Shunt.
		3	Temporal siren on alarm.	7	Force Armable.
		4	Chime.	8	Entry Guard.
		<b>Segment #3</b> (Circle numbers to program)			
		1	RESERVED.	5	<b>Dialer Delay zone.</b>
2	Double End of Line Tamper zone.	6	<b>Swinger zone.</b>		
3	<b>Trouble zone (Day zone).</b>	7	<b>Restore reporting.</b>		
4	Cross Zone.	8	<b>Listen-In.</b>		

**NX-4 Control**

**THE DEFAULTS LISTED IN THE ODD NUMBERED LOCATIONS BELOW REPRESENT THE THREE SEGMENTS OF EACH OF THOSE LOCATIONS. USE THE THREE SEGMENT CHARTS FROM LOCATION 111 TO UNDERSTAND THESE DEFAULTS.**

112	25	GROUP 2 ALARM EVENT CODE	<b>2</b>	_
113	25	GROUP 2 CHARACTERISTIC SELECT	<b>2-125-78</b>	
114	25	GROUP 3 ALARM EVENT CODE	<b>7</b>	_
115	25	GROUP 3 CHARACTERISTIC SELECT	<b>5-1245-5678</b>	
116	25	GROUP 4 ALARM EVENT CODE	<b>5</b>	_
117	25	GROUP 4 CHARACTERISTIC SELECT	<b>45-125-5678</b>	
118	25	GROUP 5 ALARM EVENT CODE	<b>5</b>	_
119	25	GROUP 5 CHARACTERISTIC SELECT	<b>457-125-5678</b>	
120	25	GROUP 6 ALARM EVENT CODE	<b>4</b>	_
121	25	GROUP 6 CHARACTERISTIC SELECT	<b>0-1245-5678</b>	
122	25	GROUP 7 ALARM EVENT CODE	<b>0</b>	_
123	25	GROUP 7 CHARACTERISTIC SELECT	<b>2-0-78</b>	
124	25	GROUP 8 ALARM EVENT CODE	<b>1</b>	_
125	25	GROUP 8 CHARACTERISTIC SELECT	<b>1-13-378</b>	
126	25	GROUP 9 ALARM EVENT CODE	<b>7</b>	_
127	25	GROUP 9 CHARACTERISTIC SELECT	<b>6-1245-5678</b>	
128	25	GROUP 10 ALARM EVENT CODE	<b>2</b>	_
129	25	GROUP 10 CHARACTERISTIC SELECT	<b>24-5-78</b>	
130	25	GROUP 11 ALARM EVENT CODE	<b>3</b>	_
131	25	GROUP 11 CHARACTERISTIC SELECT	<b>3-0-0</b>	
132	25	GROUP 12 ALARM EVENT CODE	<b>5</b>	_
133	25	GROUP 12 CHARACTERISTIC SELECT	<b>457-125-45678</b>	
134	25	GROUP 13 ALARM EVENT CODE	<b>4</b>	_
135	25	GROUP 13 CHARACTERISTIC SELECT	<b>0-12458-5678</b>	
136	25	GROUP 14 ALARM EVENT CODE	<b>7</b>	_
137	25	GROUP 14 CHARACTERISTIC SELECT	<b>5-12456-5678</b>	
138	25	GROUP 15 ALARM EVENT CODE	<b>5</b>	_
139	25	GROUP 15 CHARACTERISTIC SELECT	<b>457-1256-5678</b>	
140	25	GROUP 16 ALARM EVENT CODE	<b>4</b>	_
141	25	GROUP 16 CHARACTERISTIC SELECT	<b>0-12456-5678</b>	
142	25	GROUP 17 ALARM EVENT CODE	<b>7</b>	_
143	25	GROUP 17 CHARACTERISTIC SELECT	<b>5-1245-25678</b>	
144	25	GROUP 18 ALARM EVENT CODE	<b>5</b>	_
145	25	GROUP 18 CHARACTERISTIC SELECT	<b>457-125-25678</b>	
146	25	GROUP 19 ALARM EVENT CODE	<b>4</b>	_
147	25	GROUP 19 CHARACTERISTIC SELECT	<b>0-1245-25678</b>	
148	25	GROUP 20 ALARM EVENT CODE	<b>7</b>	_
149	25	GROUP 20 CHARACTERISTIC SELECT	<b>6-1245-25678</b>	



### APPENDIX 1 REPORTING FIXED CODES IN CONTACT ID AND SIA

The table below list the event codes sent for the following reports (if enabled) when using CONTACT ID or SIA formats.

<u>REPORT</u>	<u>CONTACT ID</u>	<u>SIA</u>
MANUAL TEST	601	RX
AUTOTEST	602	RP
OPEN (user number)	401	OP
CLOSE (user number)	401	CL
CANCEL (user number)	406	OC
DOWNLOAD COMPLETE	412	RS
START PROGRAM	627	LB
END PROGRAM	628	LX
RECENT CLOSE (user number)	401	CR
EXIT ERROR (user number)	457	EE
EVENT LOG FULL	605	JL
FAIL TO COMMUNICATE	354	RT
EXPANDER TROUBLE (device number)	333	ET
EXPANDER RESTORE (device number)	333	ER
SIREN TAMPER (device number)	321	YA
SIREN RESTORE (device number)	321	YH
AUX POWER OVER CURRENT (device number)	312	YP
AUX POWER RESTORE (device number)	312	YQ
LOW BATTERY (device number)	309	YT
LOW BATTERY RESTORE (device number)	309	YR
AC FAIL (device number)	301	AT
AC RESTORE (device number)	301	AR
BOX TAMPER (device number)	137	TA
BOX TAMPER RESTORE (device number)	137	TR
KEYPAD TAMPER	137	TA
KEYPAD PANIC (audible)	120	PA
KEYPAD PANIC (silent)	121	HA
DURESS	121	HA
KEYPAD AUXILIARY 1	110	FA
KEYPAD AUXILIARY 2	100	MA
RF SENSOR LOST (zone number)	381	*T
RF SENSOR RESTORE (zone number)	381	*R
SENSOR LOW BATTERY (zone number)	384	XT
SENSOR BATTERY RESTORE (zone number)	384	XR
ZONE TROUBLE (zone number)	380	*T
ZONE TROUBLE RESTORE (zone number)	380	*R
ZONE TAMPER (zone number)	137	TA
ZONE TAMPER RESTORE (zone number)	137	TR
ZONE BYPASS (zone number)	570	*B
BYPASS RESTORE (zone number)	570	*U

**THE NUMBER IN PARENTHESES FOLLOWING THE EVENT IS THE NUMBER THAT WILL BE REPORTED AS THE ZONE NUMBER. IF THERE ARE NO PARENTHESES, THE ZONE WILL BE A0". SEE PAGE 35 FOR THE DEVICE NUMBERS.**

**\* The character transmitted in this slot will be the first character from the event code of the zone that is bypassed or in trouble. (See locations 110 - 141)**

**APPENDIX 2 REPORTING ZONE CODES IN SIA OR CONTACT ID**

The NX-4 has the ability to report SIA level 1 transmissions to either or both phone numbers. Each report in SIA consists of an Event Code and a Zone or User ID. The Zone ID will be the zone number that is in alarm. The event code will come from the chart below and be programmed in the configuration group event code.

<b><u>Programmed Event Code</u></b>	<b><u>SIA Code</u></b>	<b><u>Description</u></b>
0	HA	Holdup Alarm
1	FA	Fire Alarm
2	PA	Panic alarm
3	BA	Burglary Alarm
4	BA	Burglary Alarm
5	BA	Burglary Alarm
6	UA	Untyped Alarm
7	BA	Burglary Alarm
8	BA	Burglary Alarm
9	UA	Untyped Alarm
10	HA	Holdup Alarm
11	MA	Medical Alarm
12	PA	Panic alarm
13	TA	Tamper Alarm
14	RP	Periodic Test
15	GA	Gas Alarm
16	KA	Heat Alarm
17	WA	Water Alarm
18	QA	Emergency Alarm
19	SA	Sprinkler Alarm
20	ZA	Freeze Alarm

The NX-4 has the ability to report Ademco Contact ID transmissions. Each report in Contact ID consists of an Event Code and a Zone ID. The zone ID is the zone that created the alarm. The event code will come from the chart below and be programmed in the configuration group event code.

<b><u>Programmed Event Code</u></b>	<b><u>Contact ID Code</u></b>	<b><u>Description</u></b>
0	122	Silent Panic
1	110	Fire Alarm
2	120	Panic alarm
3	130	Burglary Alarm
4	131	Perimeter Alarm
5	132	Interior Alarm
6	133	24 Hour Burglary
7	134	Entry Alarm
8	135	Day/Night Alarm
9	150	Non Burglary 24 Hour
10	121	Duress Alarm
11	100	Medical Alarm
12	123	Audible Panic Alarm
13	137	Tamper Alarm
14	602	Periodic Test
15	151	Gas Detected
16	158	High Temp
17	154	Water Leakage
18	140	General Alarm
19	140	General Alarm
20	159	Low Temp

**APPENDIX 3 EXPANDER NUMBERS FOR REPORTING EXPANDER TROUBLE**

The tables below list the device numbers that will be reported for trouble conditions.

Device	Device # reported
NX-4 Control Panel	0
NX-534 Two Way Listen-In	64
NX-540 AOperator® (when available)	40
NX-580 Cellemetry Interface	76
NX-582 AES Interface (when available)	77

See pages 33 - 34 for possible report codes.

**KEYPADS**

Keypad	1	2	3	4	5	6	7	8
Device #	192	200	208	216	224	232	240	248

**REMOTE POWER SUPPLY (NX-320)**

Address & Dip Switch Setting
<b>84</b> (All switches off)
<b>85</b> (Switch 1 on)
<b>86</b> (Switch 2 on)
<b>87</b> (Switch 1 & 2 on)

**OUTPUT MODULE (NX-508)**

Address & Dip Switch Setting	
<b>24</b> (Switch 1 & 2 on)	<b>28</b> (Switch 1,2,&3 on)
<b>25</b> (Switch 3 on)	<b>29</b> (All switches off)
<b>26</b> (Switch 1 & 3 on)	<b>30</b> (Switch 1 on)
<b>27</b> (Switch 2 & 3 on)	<b>31</b> (Switch 2 on)

**WIRELESS RECEIVER (NX-448)**

Switch Setting	Expander # reported
All switches off	35
Switch 1 on	32
Switch 2 on	33
Switch 1 & 2 on	34

TRANSMISSION OF THE FIRE ALARM SIGNAL TO A FIRE ALARM HEADQUARTERS OR CENTRAL STATION SHALL BE PERMITTED ONLY WITH THE APPROVAL OF THE LOCAL AUTHORITY HAVING JURISDICTION. THE BURGLAR ALARM SIGNAL SHALL NOT BE TRANSMITTED TO A POLICE EMERGENCY NUMBER. EQUIPMENT IS TO BE INSTALLED IN ACCORDANCE WITH NFPA (995.55.1.F).

# CADDX NX-4

CADDX CONTROLS, INC.  
OLADEWATER, TX 79047

This unit provides Residential fire alarm service when installed according to A167 NFPA 72-1993 (National Fire Protection Association, Batterymarch Park, Quincy, MA 02269). This unit provides Grade A Residential Burglar alarm service. In conjunction with the 1K-003-C enclosure, this unit also provides the following Commercial Burglar alarm service: Grade A Local Police Connect with Basic Line Security and Grades B & C Central Station.

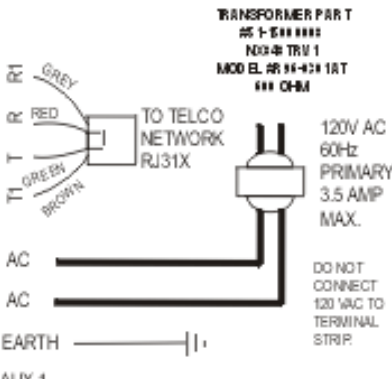
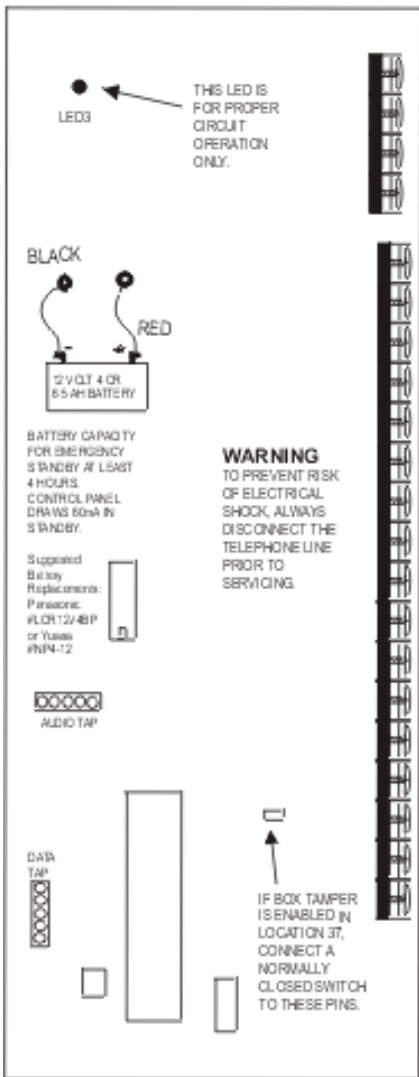

**TRANSFORMER PART**  
#5 1-5000000  
N03-TRV 1  
MOD EL. #R 11-121 1RT  
000 00-0

UL LISTED TRANSFORMER 16.5V 25, 40, OR 50 VA CLASS II. DO NOT CONNECT TO A RECEPTACLE THAT IS CONTROLLED BY A SWITCH.

DO NOT CONNECT 120 VAC TO TERMINAL STRIP.

THE TOTAL STANDBY CURRENT DRAWN FROM TERMINALS SMOKE+, KEYPAD POS AND AUX PWR+, WHEN ADDED TOGETHER, MUST NOT EXCEED 700mA WITH A 40 OR 50VA TRANSFORMER, 400mA WITH A 25VA TRANSFORMER.

**LIGHTNING PROTECTION**  
THE CONTROL PANEL MUST BE EARTH GROUND FOR LIGHTNING PROTECTION TO WORK EFFECTIVELY. THE GROUND CONNECTION SHOULD BE TIED TO A VERIFIED COLD WATER PIPE OR A DEDICATED METAL ROD 6" TO 10" LONG USE MINIMUM 14 GAUGE WIRE.

CURRENT LIMITED TO 2.5 AMP MAXIMUM.

BUILT IN SIREN DRIVER FOR 15 OR 30 WATT SPEAKERS 48 OR 16 OHM LOAD.



FOR VOLTAGE OUTPUT PROGRAM LOCATION 37, SEGMENT 2, FEATURE 1.

**ALL CIRCUITS ARE CLASS 2 POWER LIMITED, EXCEPT BATTERY CIRCUIT.**

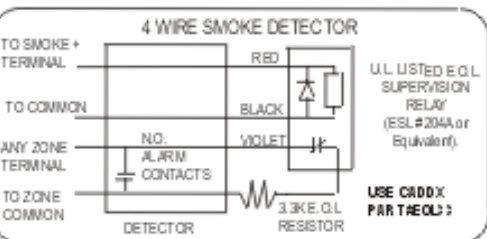

MAX TOTAL WIRE RUN IS 250 FT.  
MAX NUMBER OF DEVICES IS 8 KEYPADS AND 1 OTHER DEVICE.

**ALL ZONE INPUTS ARE SUPERVISED.**

MAX 8 KEYPADS AND 1 OTHER DEVICE  
CADDX KEYPAD PART #  
NX-108 NX-116  
NX-124 NX-128

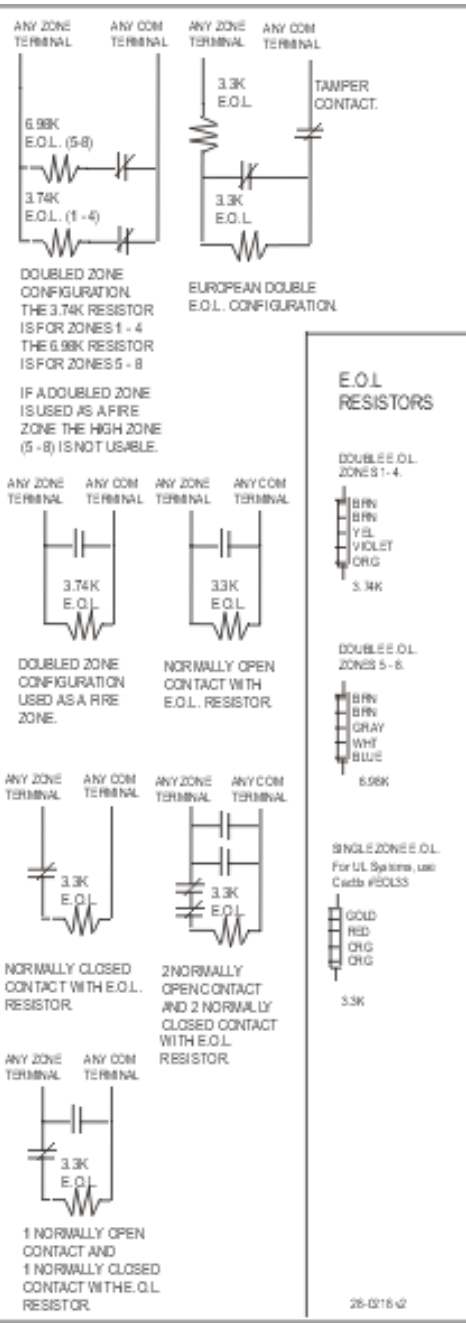

## E.O.L. RESISTORS

DOUBLE E.O.L. ZONES 1-4



DOUBLE E.O.L. ZONES 5-8



SINGLE ZONE E.O.L. For UL Systems, use Caddx #EOL3S



3.3K

26-0116-02

## NX-4 WIRING DIAGRAM

**TERMINAL DESCRIPTIONS**

TERMINAL	DESCRIPTION
<b>R1</b>	House Telephone Ring (Grey).
<b>R</b>	Telephone Ring (Red).
<b>T</b>	Telephone Tip (Green).
<b>T1</b>	House Telephone Tip (Brown).
<b>AC</b>	AC input. Connect to a 16.5V 25, 40 or 50 VA Class II U.L. approved transformer.
<b>EARTH</b>	Earth Ground. Connect to a cold water pipe or a 6 to 10 foot driven rod.
<b>AUX 1</b>	Connect negative lead of low current device [relay, LED (install 1K resistor in series with LED), etc.]. Connect positive lead of device to KEYPAD +. Current is limited to 250mA when output is negative, and 250μA when output is positive.
<b>SIREN</b>	If used as a siren output (default), the speaker rating should be 15 watt at 8 or 16 ohm, or 30/40 watt at 4, 8, or 16 ohms. If voltage output is selected in location 37, this output becomes voltage output, <b>resistor may be required across the bell terminals when a 12 VDC siren is used. If no resistor is used, you may experience voltage leakage into the siren, which will cause these devices to output a small signal.</b>
<b>COM</b>	Connect negative wire of siren/speaker or voltage output devices.
<b>SMOKE+</b>	Smoke detector power 12VDC, 250 mA maximum (For those jurisdictions which allow the Priority zone to be used with smoke detectors.)
<b>AUX 2</b>	Connect negative lead of low current device [relay, LED (install 1K resistor in series with LED), etc.]. Connect positive lead of device to KEYPAD +. Current is limited to 250mA when output is negative, and 250μA when output is positive.
<b>KEYPAD DATA</b>	Connect to the data terminal on the keypads and the expanders. MAXIMUM: 8 keypads + 1 other device.
<b>COM AUX PWR -</b>	Connect to the Common terminal on the keypads, expanders, and other power devices.
<b>POS AUX PWR +</b>	Connect to the Positive terminal on the keypads, expanders, and other power devices. This terminal is limited to 1 amp total current.
<b>ZONE 4</b>	Connect to one side of zone 4 loop. Connect the other side to com terminal. Open or short causes alarm.
<b>COM</b>	Common (-) terminal for zones 3 & 4.
<b>ZONE 3</b>	Connect to one side of zone 3 loop. Connect the other side to com terminal. Open or short causes alarm.
<b>ZONE 2</b>	Connect to one side of zone 2 loop. Connect the other side to com terminal. Open or short causes alarm.
<b>COM</b>	Common (-) terminal for zones 1 & 2.
<b>ZONE 1</b>	Connect to one side of zone 1 loop. Connect the other side to com terminal. Open or short causes alarm.

**KEYPAD MAXIMUM WIRE RUN**

**(Note:** These numbers are for one keypad at the end of the wire. When connecting more than one keypad to the end of the wire, a higher gauge wire will be required.)

Length in feet	WHEN CONNECTED TO NX-4	WHEN CONNECTED TO NX-320
	Wire Gauge	Wire Gauge
<b>250</b>	<b>24</b>	<b>22</b>
<b>500</b>	<b>20</b>	<b>18</b>
<b>1000</b>	<b>18</b>	<b>16</b>
<b>1500</b>	<b>16</b>	<b>14</b>
<b>2500</b>	<b>14</b>	<b>12</b>

**ZONE DESCRIPTIONS**

<b>1</b>	
<b>2</b>	
<b>3</b>	
<b>4</b>	
<b>5</b>	
<b>6</b>	
<b>7</b>	
<b>8</b>	

**DECLARATION**

***(Applies to products which have the CE mark attached)***

This equipment has been approved in accordance with Council Decision 98/482/EC for Pan-European single terminal connection to the public switched telephone network (PSTN). However, due to differences between the individual PSTNs provided in different countries, the approval does not, of itself, give an unconditional assurance of successful operation on every PSTN network termination point.

In the event of problems, you should contact your equipment supplier in first instance.

**LOCAL TELEPHONE COMPANY INTERFACE INFORMATION****TELEPHONE CONNECTION REQUIREMENTS**

Except for telephone company provided ringers, all connections to the telephone network shall be made through standard plugs and standard telephone company provided jacks or equivalent in such a manner as to allow for immediate disconnection of the terminal equipment. Standard jacks shall be so arranged that if the plug connected thereto is withdrawn, no interference to the operation of the equipment at the customers premises which remains connected to the telephone network, shall occur by reason of such withdrawal.

**INCIDENCE OF HARM**

Should terminal equipment or protective circuitry cause harm to the telephone network, the telephone company shall, where practical, notify the customer that temporary discontinuance of service may be required. However, where prior notice is not practical, the telephone company may temporarily discontinue service if such action is deemed reasonable in the circumstances. In the case of such temporary discontinuance, the telephone company shall promptly notify the customer who will be given the opportunity to correct the situation. The customer also has the right to bring a complaint to the FCC if he feels the disconnection is not warranted.

**CHANGES IN TELEPHONE COMPANY EQUIPMENT OR FACILITIES**

The telephone company may make changes in its communications facilities, equipment, operations, or procedures where such action is reasonably required and proper in its business. Should any such change render the customers terminal equipment incompatible with the telephone company facilities, the customer shall be given adequate notice to make modifications to maintain uninterrupted service.

**GENERAL**

The FCC prohibits customer provided terminal equipment be connected to party lines.

**IMPORTANCE OF THE RINGER EQUIVALENCE NUMBER**

The Ringer Equivalence Number (REN) of this device is 0.1B. This number is a representation of the electrical load that it applies to your telephone line.

**MALFUNCTION OF THE EQUIPMENT**

In the event that the device should fail to operate properly, the customer shall disconnect the equipment from the telephone line to determine if it is the customers equipment that is not functioning properly. If the problem is with the device, the customer shall discontinue use until it is repaired.

**EQUIPMENT INFORMATION**

MANUFACTURER OF CONNECTING EQUIPMENT: **CADDX CONTROLS, INC.**  
FCC REGISTRATION NUMBER: GCQUSA-33408-AL-E, RINGER EQUIVALENCE: 0.1 B

**UNDERWRITERS LABORATORIES INFORMATION**

The NetworX NX-4 holds the following listings from Underwriters Laboratories:

**Household Burglary (UL1023)**

**Household Fire (UL985)**

**Local Grade A Mercantile, Police Station Connect with Basic Line Security (UL609) (requires #NX-003-C enclosure)**

**Grade B & C Central Station Burglar Alarm Unit (UL1635)**

**Home Health Care Signaling (UL1637)**

When installing an NX-4 in compliance with Underwriters Laboratories, the following instructions must be observed:

- ! Initiating and indicating devices must be rated at 11.5 to 12.4 V DC residential, 12.0 V DC commercial.
- ! Force Arming and Auto Arming shall not be enabled.
- ! For residential fire applications, the indicating devices shall be a Wheelock 34T-12 or equivalent.
- ! The "Listen-In" feature shall not be enabled.
- ! The Siren/Bell Test shall be enabled. The auxiliary outputs controlling the audible device require a minimum cutoff time of 15 minutes for commercial burglary or 4 minutes for residential applications.
- ! For residential fire installations, the Dynamic Battery Test time cannot exceed four (4) hours.
- ! Ringback shall be enabled on UL commercial burglary installations.
- ! On commercial burglary installations, the fire initiating circuits shall not be connected.
- ! The Entry-Guard feature shall be disabled.
- ! Swinger Shutdown shall be disabled.
- ! Group Bypassing shall be disabled.
- ! Delay before dial seizure shall be set to "0".
- ! Total current draw from aux power connections at terminal positions POS, AUX PWR, and SMOKE PWR must not exceed 400 mA.
- ! Remote Downloading shall not be used on UL listed systems.
- ! For residential burglary applications, the maximum entry and exit delay times shall be 45 and 60 seconds respectively. The exit delay time shall not exceed 60 seconds for commercial burglar alarm applications.
- ! The keyswitch option shall not be used.
- ! The telephone line monitor shall be enabled.
- ! The Telephone Line Cut delay shall not exceed 90 seconds.
- ! 24-hour communicator test transmission is required.
- ! For 24 hours of standby power using a 7.0 AH battery, limit auxiliary power load to 140 mA.
- ! For 24 hours of standby power using a 17.2 AH battery, limit auxiliary power load to 400 mA.
- ! The silent keypad option shall not be enabled.
- ! UL has only verified compatibility with the following listed DACRs and formats: Sure-Gard SG-MLR2-DG: 2,9,10,12,13,14; Silent Knight 9000 - 2,12; FBI - CP220FBI, 13; and Ademco 685: 2,11,12, and 13.
- ! For burglary installations, cross-zoned detectors shall overlap 100 percent in the area of coverage and similar coverage areas must be used. For example, interior protection is cross-zoned with interior protection, etc.
- ! Expander trouble must activate the siren (Loc 37, Segment 2, LED 2)
- ! For UL 1637, expander trouble must activate keypad sounder (Loc 39, Segment 1, LED 8)
- ! The keypad used with wireless receivers and hardwire expansion must be able to display all zones in a system.

**MINIMUM SYSTEM CONFIGURATIONS FOR UL INSTALLATIONS  
(Residential Fire, Residential Burglary, Commercial Burglary)**

- ! The NetworX NX-4 panel is necessary to initiate Residential and Commercial installations.
- ! At least one compatible keypad is needed for all applications.
- ! At least one bell fixture is required for all applications, except Grade C Central Station. For Grade A Local, the AD10-12 bell and Grade A bell housing shall be used.
- ! Commercial UL applications require #NX-003-C metal enclosure. Supplied screws to be used.
- ! A minimum of two (2) keypads are required for Home Health applications and each keypad must be set to a unique address.
- ! The wireless devices are only UL listed for residential applications.
- ! The DACT shall be enabled for all commercial burglary applications.



**SYSTEM NOTES**

## SPECIFICATIONS

<b>OPERATING POWER</b>	<b>16.5 VAC 25, 40, or 50 VA Transformer</b>
<b>AUXILIARY POWER</b>	
w/25 VA Transformer	<b>12 VDC Regulated 500 mA</b>
w/40 or 50 VA Transformer	<b>12 VDC Regulated 1 AMP</b>
<b>LOOP RESISTANCE</b>	
Standard Loop	<b>300 Ohms Maximum</b>
<b>BUILT-IN SIREN DRIVER</b>	<b>2-tone (Temporal and Yelp)</b>
<b>LOOP RESPONSE</b>	<b>500mS</b>
<b>OPERATING TEMPERATURE</b>	<b>32 to 120 degrees F</b>
<b>LED KEYPAD</b>	
Current Draw	<b>130 mA max.</b>
Zones Normal w/o Sounder	<b>55 mA</b>
Dimensions	<b>6.4" Wide</b>
	<b>4.0" High</b>
	<b>1.1" Deep</b>
<b>NX-148 LCD KEYPAD</b>	
Current Draw	<b>110 mA max.</b>
w/o Sounder	<b>75 mA</b>
Dimensions	<b>6.4" Wide</b>
	<b>5.3" High</b>
	<b>1.0" Deep</b>
<b>METAL ENCLOSURE DIMENSION</b>	<b>9.25" Wide</b>
	<b>8.25" High</b>
	<b>3.50" Deep</b>
<b>SHIPPING WEIGHT</b>	<b>9 lbs.</b>

### FIVE YEAR LIMITED WARRANTY

CADDX CONTROLS, INC. GUARANTEES THIS PRODUCT AGAINST DEFECTIVE PARTS AND WORKMANSHIP FOR TWENTY-FOUR (24) MONTHS FROM DATE OF MANUFACTURING. IF ANY DEFECT APPEARS DURING THE WARRANTY PERIOD, RETURN IT TO CADDX POSTAGE PREPAID. THE UNIT WILL BE REPAIRED AND RETURNED AT NO CHARGE.

FOR THE REMAINING 36 MONTHS OF WARRANTY, THE CHARGE TO REPAIR OR REPLACE THIS UNIT WILL NOT EXCEED \$10.00 PLUS SHIPPING AND HANDLING.

CADDX ASSUMES NO LIABILITY FOR CONSEQUENTIAL OR INDIRECT DAMAGE AND ACCEPTS NO RESPONSIBILITY FOR REPAIRING DAMAGE TO THE PRODUCT CAUSED BY MISUSE, CARELESS HANDLING, OR WHERE REPAIRS HAVE BEEN MADE BY OTHERS.

NO OTHER GUARANTEE, WRITTEN OR VERBAL, IS AUTHORIZED BY OR ON BEHALF OF CADDX CONTROLS, INC., GLADEWATER, TEXAS.

**CADDX CONTROLS, INC.**  
**1420 N. MAIN STREET; GLADEWATER, TEXAS 75647**  
**TOLL FREE 800-727-2339**  
**FAX 903-845-6811**  
**[www.caddx.com](http://www.caddx.com)**